

15W, AC-DC converter



FEATURES

- Wide input voltage range: 85 - 264VAC/100 - 370VDC
- Regulated output, Low ripple & noise
- High efficiency up to 84%
- Output short circuit, over-current, over-voltage protection
- Plastic case, meets UL94V-0
- IEC60950, UL60950, EN60950 approval
- Mounting: PCB mounting, Chassis mounting, DIN-Rail mounting available



LH15 series — a compact size power converter offered by Mornsun. It features universal input voltage, taking both DC and AC input voltage, low power consumption, high efficiency, high reliability, safer isolation. It offers good EMC performance, which meet IEC/EN61000-4, CISPR22/EN55022, UL60950 and EN60950 standards, and it's widely used in industrial, office and civil applications. For harsh EMC environment, the application circuit in the datasheet is strongly recommended.

Selection Guide

Certification	Part No.*	Output Power	Nominal Output Voltage and Current		Efficiency (230VAC, %/Typ.)	Max. Capacitive Load(μF)	
			(Vo1/Io1)	(Vo2/Io2)		Vo1	Vo2
UL/CE/CB	LH15-10B03	9.9W	3.3V/3000mA	--	73	36000	--
	LH15-10B05	14W	5V/2800mA	--	76	20000	--
	LH15-10B09	15W	9V/1600mA	--	78	8000	--
	LH15-10B12		12V/1250mA	--	80	5200	--
	LH15-10B15		15V/1000mA	--	80	5000	--
	LH15-10B24		24V/625mA	--	84	900	--
--	LH15-10A05	15W	+5V/1500mA	-5V/1500mA	76	12800	12800
	LH15-10A12		+12V/650mA	-12V/650mA	81	2350	2350
	LH15-10A15		+15V/500mA	-15V/500mA	83	3120	3120
	LH15-10A24		+24V/310mA	-24V/310mA	83	400	400
UL/CE/CB	LH15-10C0505-05	15W	5V/2000mA	±5V/500mA	75	10800	2160
	LH15-10C0512-02		5V/2000mA	±12V/200mA	77	17280	2160
	LH15-10C0515-02		5V/1800mA	±15V/200mA	78	5920	370
	LH15-10C0524-01		5V/2000mA	±24V/100mA	78	1600	130
--	LH15-10D0505-08	15W	5V/2200mA	5V/800mA	78	15000	3000
	LH15-10D0512-04		5V/2000mA	12V/400mA	80	12000	1800
	LH15-10D0515-03		5V/2000mA	15V/300mA	81	10000	1500
CE	LH15-10D0524-02	15W	5V/2000mA	24V/200mA	81	13000	800

Note: *About LH15-10AXX, use both positive and negative output as sampling feedback; and all others use Vo1 as sampling feedback.

Input Specifications

Item	Operating Conditions	Min.	Typ.	Max.	Unit
Input Voltage Range	AC Input	85	--	264	VAC
	DC input	100	--	370	VDC
Input frequency		47	--	63	Hz
Input current	115VAC	--	--	0.37	A
	230VAC	--	--	0.22	
Inrush current	115VAC	--	10	--	
	230VAC	--	20	--	

Leakage current		0.3mA RMS typ./230VAC/50Hz
Recommended External Input Fuse(Special package series include fuse)		2A/250V, slow fusing
Hot Plug		Unavailable

Output Specifications

Item	Operating Conditions		Min.	Typ.	Max.	Unit	
Output Voltage Accuracy	Main circuit	3.3V Output	--	±3	--	%	
		Others output	--	±2	--		
Line Regulation	Full load	Main circuit	--	±0.5	--		
		Auxiliary circuit	--	±1.5	--		
Load Regulation	10% - 100% load	Single output	--	±1	--		
		Dual output(balanced load)	--	±2	--		
		Isolated triple output (balanced load)	Main circuit Vo1	--	±3		--
			Auxiliary circuit ±Vo2	--	±5		--
		Isolated and separated twin output (balanced load)	Main circuit Vo1	--	±3	--	
			Auxiliary circuit Vo2	--	±5	--	
Ripple & Noise*	Main circuit	20MHz bandwidth (peak-peak value)		--	50	100	mV
Temperature Coefficient	Main circuit		--	±0.02	--	%/°C	
Short Circuit Protection			Continuous, self-recovery				
Over-current Protection			≥110%Io self-recovery				
Over-voltage Protection	Main circuit	3.3 / 5VDC Output	≤7.5VDC				
		9VDC Output	≤13VDC				
		12 / 15VDC Output	≤20VDC				
		24VDC Output	≤30VDC				
Min. Load	Single output		0	--	--	%	
	Dual output (balanced load)		10	--	--		
	Isolated and separated twin output (balanced load)		10	--	--		
	Isolated triple output (balanced load)		10	--	--		
Hold-up Time	115VAC input		--	15	--	ms	
	230VAC input		--	80	--		

Note: * Ripple and noise are measured by "parallel cable" method, please see AC-DC Converter Application Notes for specific operation.

General Specifications

Item	Operating Conditions		Min.	Typ.	Max.	Unit
Isolation Voltage	Input-output	Test time: 1min	3000	--	--	VAC
	Input- 		2000	--	--	
Operating Temperature			-40	--	+70	°C
Storage Temperature			-40	--	+105	
Storage Humidity			--	--	95	%RH
Welding Temperature	Wave-soldering		260 ± 5°C; time: 5 - 10s			
	Manual-welding		360 ± 10°C; time: 3 - 5s			
Switching Frequency			--	65	--	kHz
Power Derating	-40°C to -10°C		2.0	--	--	% / °C
	+55°C to +70°C		4.0	--	--	
Safety Standard			IEC60950/EN60950/UL60950			
Safety Certification			IEC60950/EN60950/UL60950			
Safety Class	Single output		CLASS II			
	Other series		CLASS I			
MTBF			MIL-HDBK-217F@25°C > 300,000 h			

Physical Specifications

Casing Material	Black flame-retardant and heat-resistant plastic (UL94V-0)	
Dimension	Horizontal package	62.00*45.00* 22.50mm
	A2 chassis mounting	96.10*54.00*31.00mm
	A3 chassis mounting	99.00*54.00*31.00 mm
	A4 Din-Rail mounting	96.10*54.00*35.60 mm
Weight	Horizontal package/A2 chassis mounting /A3 chassis mounting/A4 Din-Rail mounting	85g/135g/135g/175g(Typ.)
Cooling method	Free air convection	

EMC Specifications

EMI	CE	CISPR22/EN55022	CLASS B	
	RE	CISPR22/EN55022	CLASS B	
EMS	ESD	IEC/EN61000-4-2	Contact $\pm 6KV$ /Air $\pm 8KV$	Perf. Criteria B
	RS	IEC/EN61000-4-3	10V/m	perf. Criteria A
	EFT	IEC/EN61000-4-4	$\pm 2KV$	perf. Criteria B
		IEC/EN61000-4-4	$\pm 4KV$ (See Fig. 5 for recommended circuit)	perf. Criteria B
	Surge	IEC/EN61000-4-5	line to line $\pm 1KV$ /line to ground $\pm 2KV$	perf. Criteria B
		IEC/EN61000-4-5	line to line $\pm 2KV$ /line to ground $\pm 4KV$ (See Fig. 5 for recommended circuit)	perf. Criteria B
	CS	IEC/EN61000-4-6	10 Vr.m.s	perf. Criteria A
	PFM	IEC/EN61000-4-8	10A/m	perf. Criteria A
Voltage dips, short interruptions and voltage variations immunity		IEC/EN61000-4-11	0%,70%	perf. Criteria B

Product Characteristic Curve

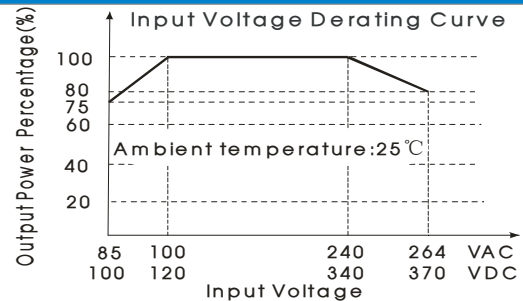
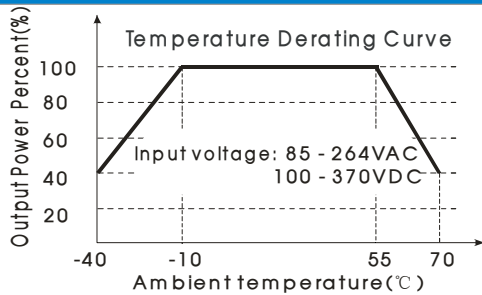

Note:

- ①When input 85 - 100VAC/240 - 264VAC/100 - 120VDC/340 - 370VDC, it need to be voltage derated on basis of temperature derating;
- ②This product is suitable for use in natural air cooling environments, if in a closed environment, please contact our company's FAE.

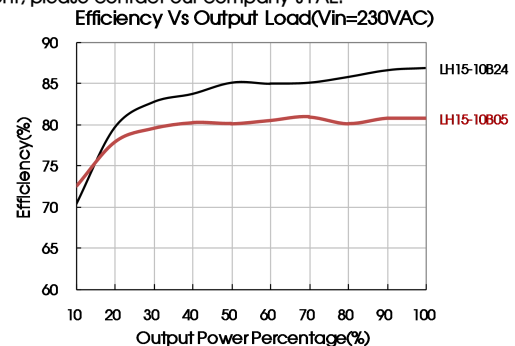
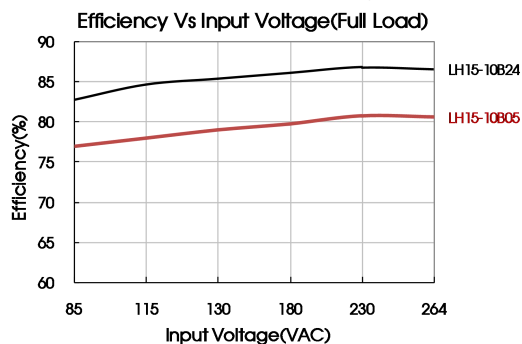

Design Reference

1. Typical application circuit

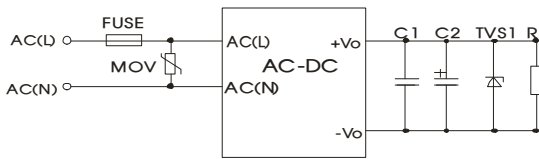

Fig. 1: Typical application circuit

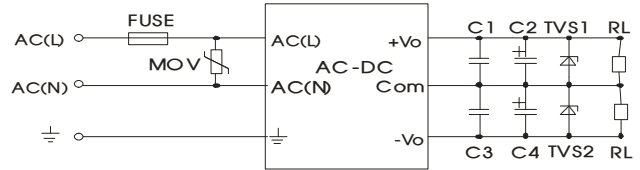

Fig. 2: LH15-10Axx (Dual Output) series typical application circuit

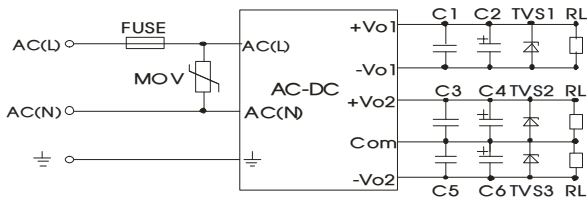

Fig. 3: LH15-10Cxx (Triple Output) series typical application circuit

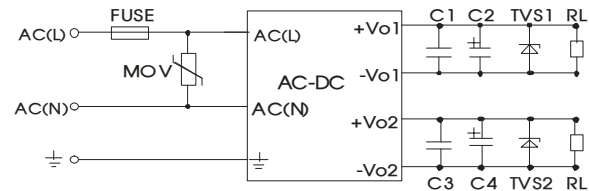

Fig. 4: LH15-10Dxx (Isolate Twin Output) series typical application circuit

Model	C2(μ F)	C4(μ F)	C6(μ F)	TVS1	TVS2	TVS3
LH15-10B03	680	--	--	SMBJ7.0A	--	--
LH15-10B05	680	--	--	SMBJ7.0A	--	--
LH15-10B09	470	--	--	SMBJ12A	--	--
LH15-10B12	220	--	--	SMBJ20A	--	--
LH15-10B15	220	--	--	SMBJ20A	--	--
LH15-10B24	68	--	--	SMBJ30A	--	--
LH15-10A05	470	470	--	SMBJ7.0A	SMBJ7.0A	--
LH15-10A12	220	220	--	SMBJ20A	SMBJ20A	--
LH15-10A15	120	120	--	SMBJ20A	SMBJ20A	--
LH15-10A24	68	68	--	SMBJ30A	SMBJ30A	--
LH15-10C0505-05	470	220	220	SMBJ7.0A	SMBJ7.0A	SMBJ7.0A
LH15-10C0512-02	470	120	120	SMBJ7.0A	SMBJ20A	SMBJ20A
LH15-10C0515-02	470	120	120	SMBJ7.0A	SMBJ20A	SMBJ20A
LH15-10C0524-01	470	120	120	SMBJ7.0A	SMBJ30A	SMBJ30A
LH15-10D0505-08	470	470	--	SMBJ7.0A	SMBJ7.0A	--
LH15-10D0512-04	470	220	--	SMBJ7.0A	SMBJ20A	--
LH15-10D0515-03	470	120	--	SMBJ7.0A	SMBJ20A	--
LH15-10D0524-02	470	47	--	SMBJ7.0A	SMBJ30A	--

Note:
Output filtering capacitors C2, C4, C6 are electrolytic capacitors, it is recommended to use high frequency and low impedance electrolytic capacitor. For capacitance and current of capacitor please refer to manufacture's datasheet. Capacitor withstand voltage derating should be 80% or above. C1, C3, C5 are ceramic capacitors, which is used to filter high-frequency noise, advice use 1 μ F. TVS is a recommended component to protect post-circuits if converter fails. External input MOV model is recommended to use S14K300.

2. EMC solution-recommended circuit

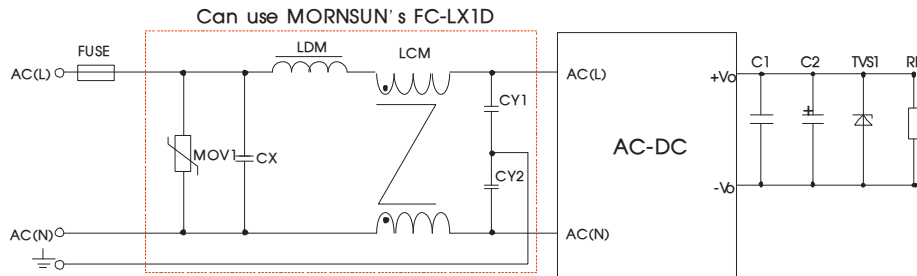
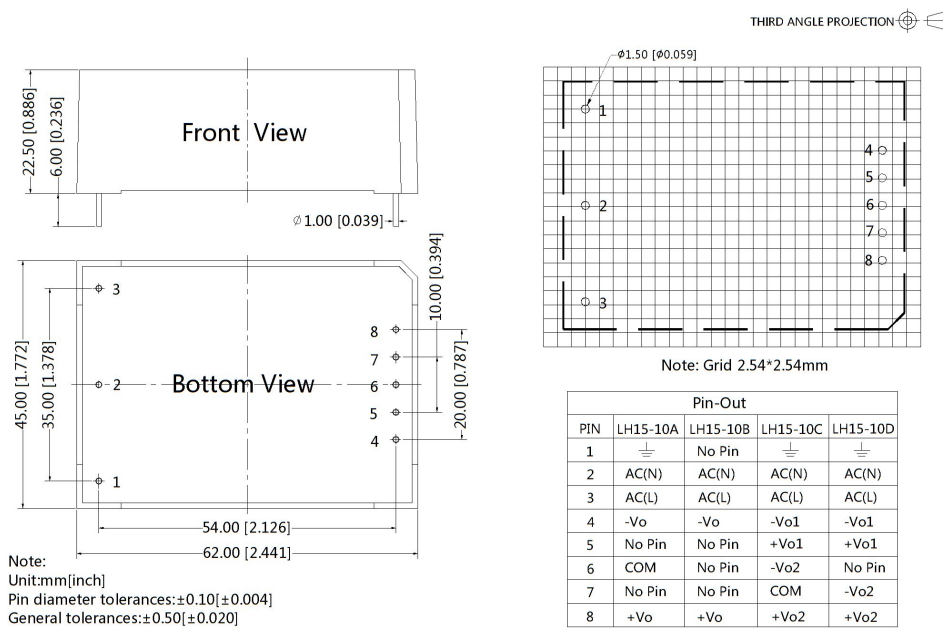

Fig 5: EMC Recommended circuit with higher requirements
(Output external circuit refer to the typical application circuit)

Element model	Recommended value
MOV1	S14K300
CY1 , CY2	1000pF/400VAC
CX	0.1μF/275VAC
LCM	10mH, recommended to use MORNSUN's FL2D-Z5-103
LDM	4.7μH/2A
FC-LX1D	2KV/4KV EMC filter
FUSE	2A/250V slow fusing, necessary

3. For more information, Please find the application note on www.mornsun-power.com



Dimensions and Recommended Layout

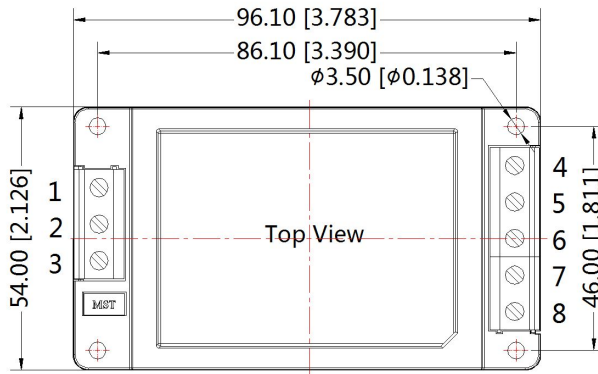

A2 Dimensions

THIRD ANGLE PROJECTION 



Pin	LH15-10A	LH15-10B	LH15-10C	LH15-10D
1		NC		
2	AC(N)	AC(N)	AC(N)	AC(N)
3	AC(L)	AC(L)	AC(L)	AC(L)
4	-Vo	-Vo	-Vo1	-Vo1
5	NC	NC	+Vo1	+Vo1
6	COM	NC	-Vo2	NC
7	NC	NC	COM	-Vo2
8	+Vo	+Vo	+Vo2	+Vo2

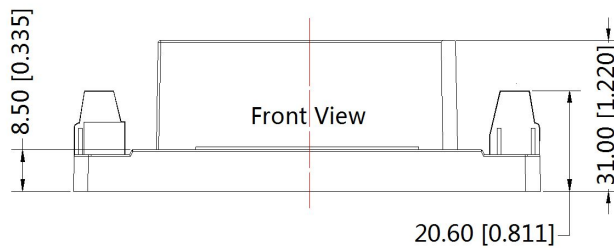



Note:
Unit:mm[inch]
Wire range : 24-12 AWG
Tightening torque: Max 0.4 N·m
General tolerances:±0.50[±0.020]

A3 Dimensions

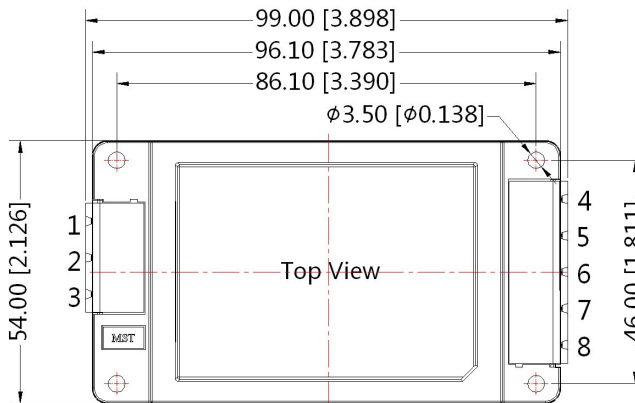
THIRD ANGLE PROJECTION 



Pin	LH15-10A	LH15-10B	LH15-10C	LH15-10D
1		NC		
2	AC(N)	AC(N)	AC(N)	AC(N)
3	AC(L)	AC(L)	AC(L)	AC(L)
4	-Vo	-Vo	-Vo1	-Vo1
5	NC	NC	+Vo1	+Vo1
6	COM	NC	-Vo2	NC
7	NC	NC	COM	-Vo2
8	+Vo	+Vo	+Vo2	+Vo2

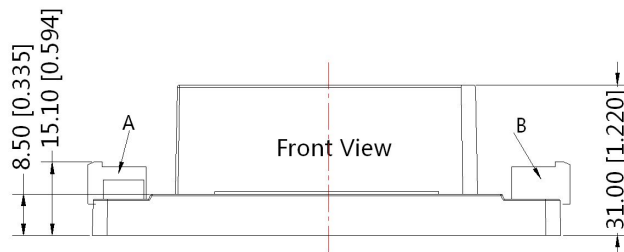



Note:
Unit:mm[inch]
General tolerances:±0.50[±0.020]
A:DEGSON P/N: 2EDGRC-7.5-03P-14-100A (H)
B: DEGSON P/N: 2EDGRC-7.5-05P-14-100A (H)

A4 Dimensions

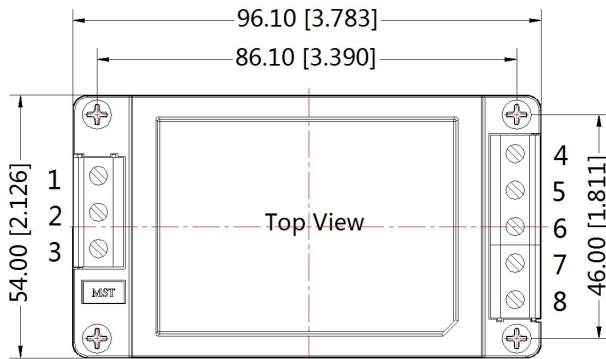
THIRD ANGLE PROJECTION 



Pin	LH15-10A	LH15-10B	LH15-10C	LH15-10D
1		NC		
2	AC(N)	AC(N)	AC(N)	AC(N)
3	AC(L)	AC(L)	AC(L)	AC(L)
4	-Vo	-Vo	-Vo1	-Vo1
5	NC	NC	+Vo1	+Vo1
6	COM	NC	-Vo2	NC
7	NC	NC	COM	-Vo2
8	+Vo	+Vo	+Vo2	+Vo2

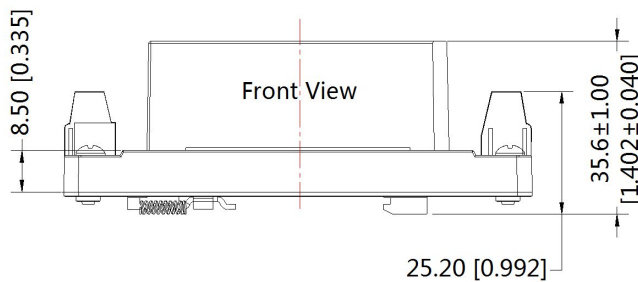

Note:
Unit: mm[inch]
Wire range: 24-12 AWG
Tightening torque: Max 0.4 N·m
Mounting rail: TS35, rail needs to connect safety ground
General tolerances: ± 0.50 [± 0.020]

- Note:
1. Packing information please refer to Product Packing Information which can be downloaded from www.mornsun-power.com. Packing bag number of Horizontal package: 58220006; the Packing bag number of A2/A3/A4 package: 58220010;
 2. If the product is not operated within the required load range, the product performance cannot be guaranteed to comply with all parameters in the datasheet;
 3. Unless otherwise specified, parameters in this datasheet were measured under the conditions of $T_a=25^\circ\text{C}$, humidity<75% with nominal input voltage and rated output load;
 4. All index testing methods in this datasheet are based on our Company's corporate standards;
 5. We can provide product customization service, please contact our technicians directly for specific information;
 6. Specifications are subject to change without prior notice.

Mornsun Guangzhou Science & Technology Co., Ltd.

Address: No. 5, Kehui St. 1, Kehui Development Center, Science Ave., Guangzhou Science City, Luogang District, Guangzhou, P. R. China
Tel: 86-20-38601850-8801 Fax: 86-20-38601272 E-mail: info@mornsun.cn