

LTE MIMO Combination Antenna

JCG305LM

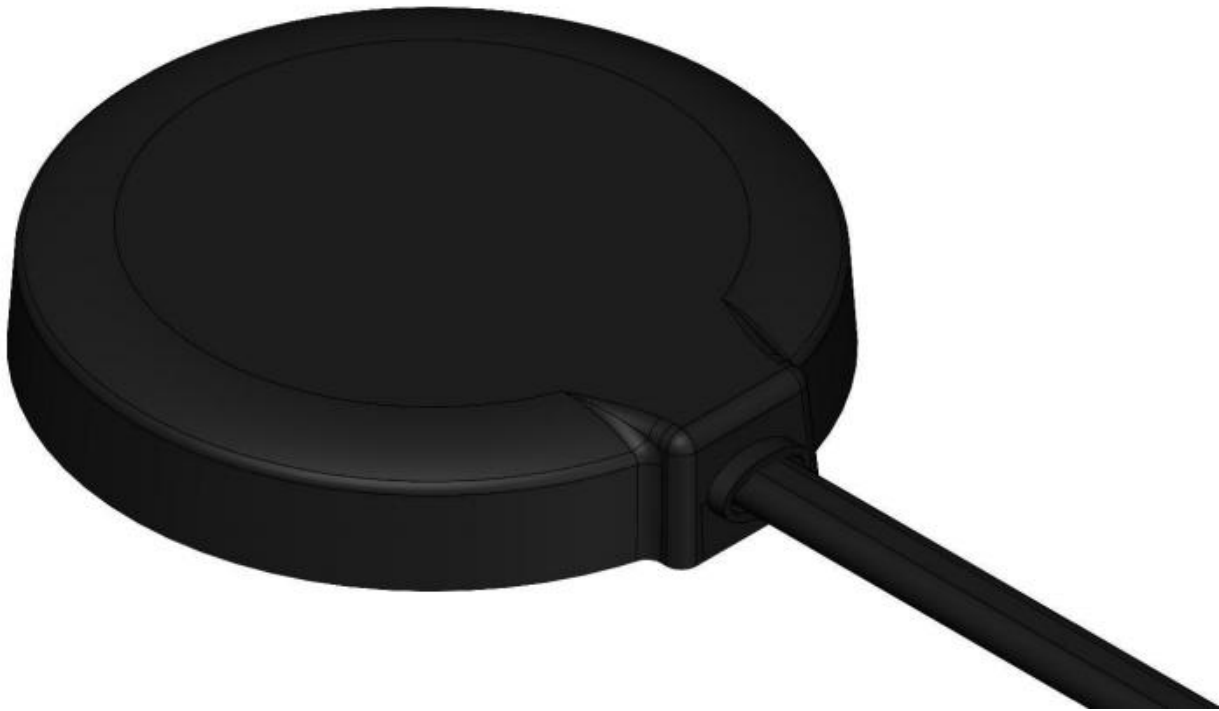

DIMENSIONS

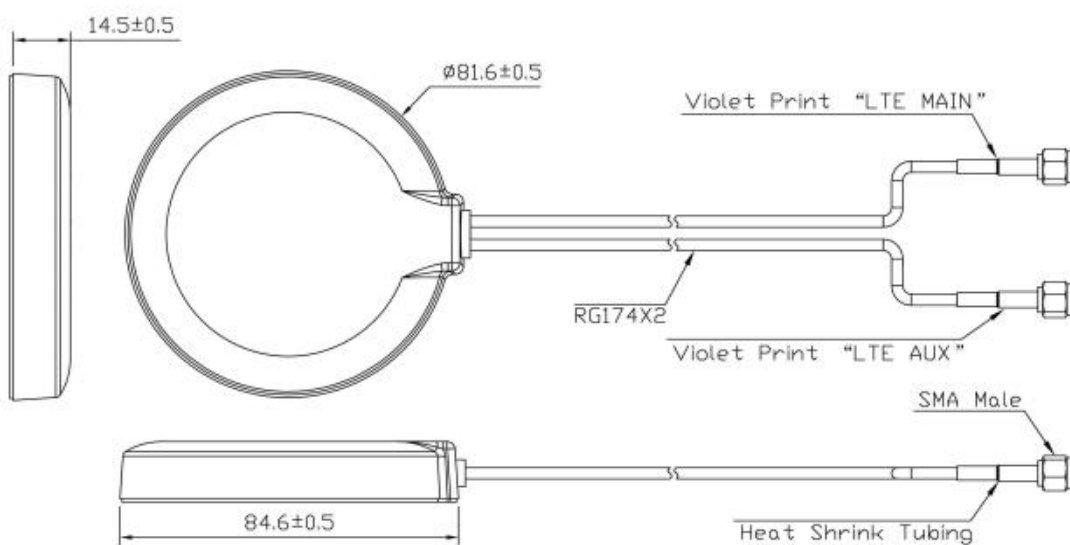

Unit:mm

SPECIFICATIONS

Item	Specifications	
LTE Antenna MAIN	Frequency Range	698~960MHz/1710~2690MHz
	V.S.W.R	<3.0
	Polarization	Linear
	Gain	2.5dBi (Zenith)
	Impedance	50Ω
LTE Antenna AUX	Frequency Range	698~960MHz/1710~2690MHz
	V.S.W.R	<3.0
	Polarization	Linear
	Gain	2.0dBi (Zenith)
	Impedance	50Ω
Mechanical	Cable	RG174
	Connector	SMA/FAKRA or others
	Material	ABS
	Mounting Method	Adhesive/Magnet
Environmental	Operating Temperature	-40°C~+85°C
	Relative Humidity	Up to 95%
	Ingress Protection	IP67
	Vibration	10 to 55Hz with 1.5mm amplitude 2hours
	Environmentally Friendly	ROHS Compliant

Radiation Pattern



LTE Antenna MAIN

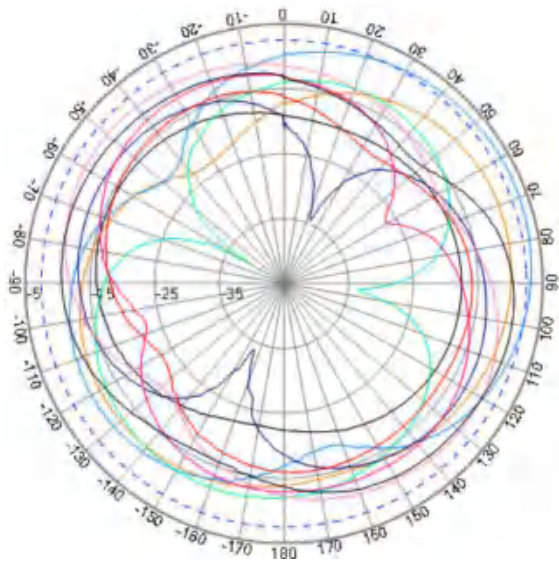

XY PLANE

- 测试频率: 700
- 测试频率: 824
- 测试频率: 868
- 测试频率: 960
- 测试频率: 1710
- 测试频率: 1850
- 测试频率: 1990
- 测试频率: 2170
- 测试频率: 2690

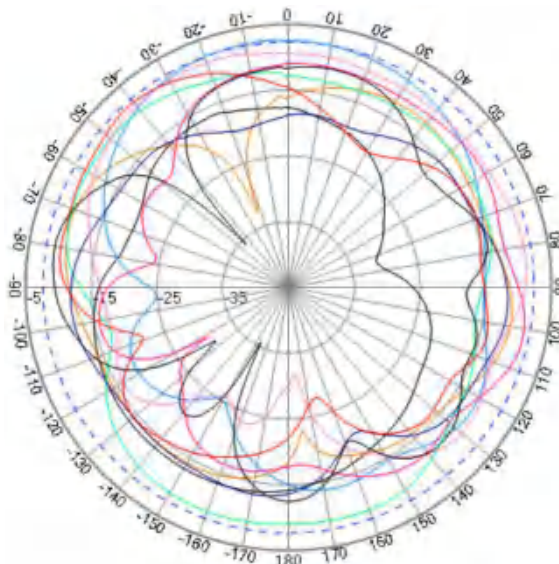

XZ PLANE

- 测试频率: 700
- 测试频率: 824
- 测试频率: 868
- 测试频率: 960
- 测试频率: 1710
- 测试频率: 1850
- 测试频率: 1990
- 测试频率: 2170
- 测试频率: 2690

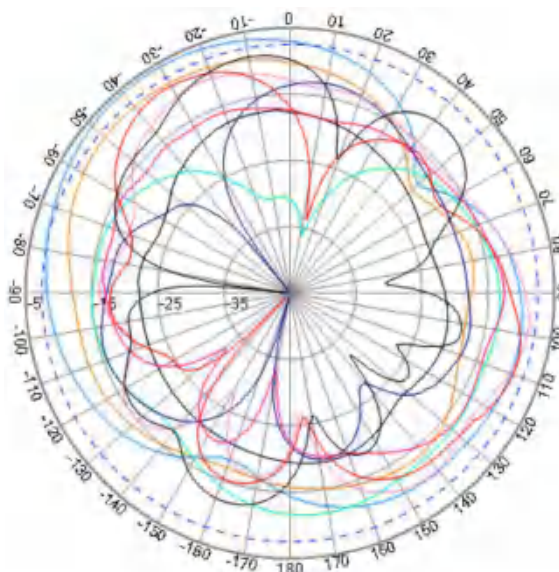

YZ PLANE

- 测试频率: 700
- 测试频率: 824
- 测试频率: 868
- 测试频率: 960
- 测试频率: 1710
- 测试频率: 1850
- 测试频率: 1990
- 测试频率: 2170
- 测试频率: 2690

LTE Antenna AUX

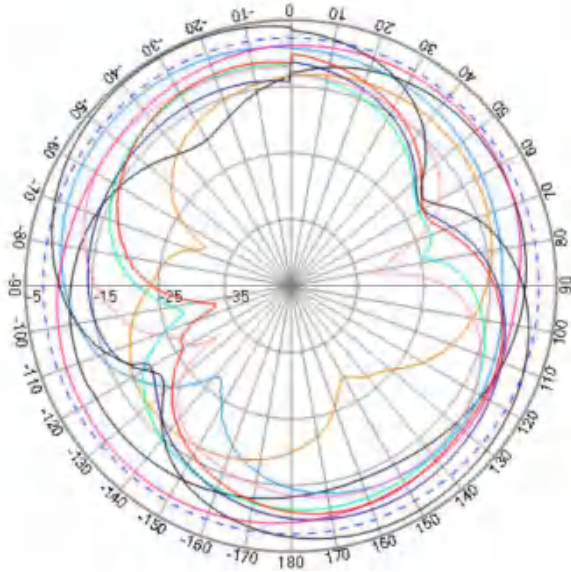

XY PLANE

- 测试频率: 700
- 测试频率: 824
- 测试频率: 868
- 测试频率: 960
- 测试频率: 1710
- 测试频率: 1850
- 测试频率: 1990
- 测试频率: 2170
- 测试频率: 2690

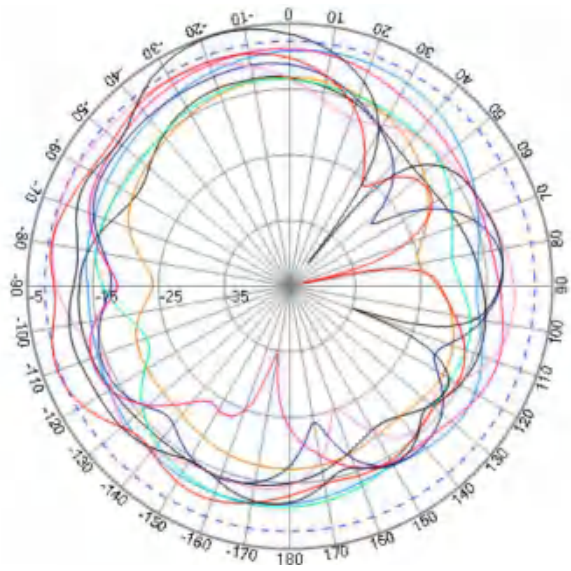

XZ PLANE

- 测试频率: 700
- 测试频率: 824
- 测试频率: 868
- 测试频率: 960
- 测试频率: 1710
- 测试频率: 1850
- 测试频率: 1990
- 测试频率: 2170
- 测试频率: 2690

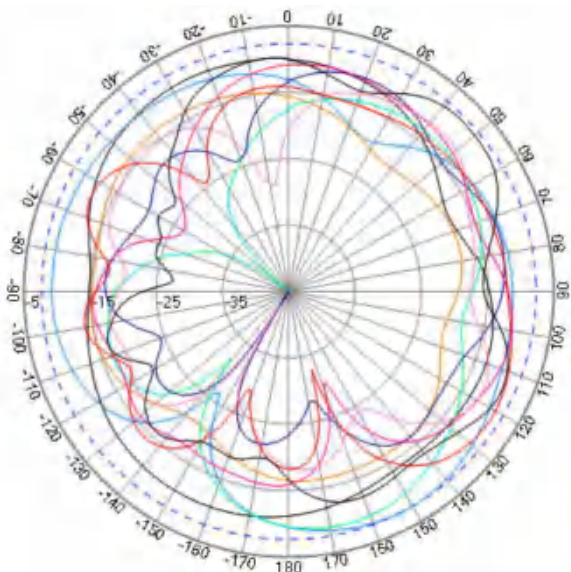

YZ PLANE

- 测试频率: 700
- 测试频率: 824
- 测试频率: 868
- 测试频率: 960
- 测试频率: 1710
- 测试频率: 1850
- 测试频率: 1990
- 测试频率: 2170
- 测试频率: 2690