

Superior Efficacy & Lumen output with Small Form Factor

SZR15A0B

S1CH-3535620003-00000000-00001

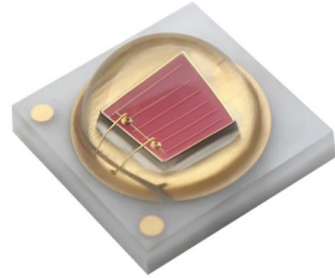

Product Brief

Description

- The Z-Power series is designed for high flux output applications with high current operation capability.
- It incorporates state of the art SMD design and low thermal resistant material.
- The Z Power LED is ideal light sources for directional lighting applications such as Spot Lights, various outdoor applications and high performance torches .

Features and Benefits

- Super high Flux output and high Luminance
- Designed for high current operation
- SMT solderable
- Lead Free product
- RoHS compliant

Key Applications

- Collecting fish
- General Torch
- Architectural lighting
- Projector light source
- Traffic signals
- Task lighting
- Decorative / Pathway / lighting
- Remote / Solar / Powered lighting

Table of Contents

Index	
• Product Brief	1
• Table of Contents	2
• Performance Characteristics	3
• Characteristics Graph	5
• Mechanical Dimensions	9
• Recommended Solder Pad	10
• Reflow Soldering Characteristics	11
• Packaging Information	14
• Product Nomenclature	15
• Handling of Silicone Resin for LEDs	16
• Precaution For Use	17
• Company Information	20

Performance Characteristics

Table 1. Electro-Optical characteristics at 350mA (Ta=25°C, RH30%)

Parameter	Symbol	Value			Unit
		Min.	Typ.	Max.	
Flux ^[1]		-	90	-	Lm
Peak Wavelength	λ_p	620		635	nm
Forward Voltage (@350mA) ^[3]	V_F	1.95	2.25	2.55	V
Thermal resistance (J to S)	$R\theta_{J-S}$	-	3.5	-	K/W
View Angle	$2\theta \frac{1}{2}$		125		deg.

Table 2. Absolute Maximum Ratings

Parameter	Symbol	Value			Unit
		Min.	Typ.	Max.	
Forward Current	I_F	-	350	800	mA
Reverse Voltage	V_R	-	-	5	V
Junction Temperature	T_j	-	-	135	°C
Storage Temperature	T_{stg}	- 10	-	85	°C
ESD Sensitivity(HBM) ^[4]		-	-	8	kV

Notes :

- (1) SSC maintains a tolerance of $\pm 7\%$ on power measurements.
 - (2) Photosynthetic Photon Flux includes wavelengths between 400 and 700 nm.
 - (3) Tolerance is $\pm 0.06V$ on forward voltage measurements
 - (4) The zener diode is included to protect the product from ESD.
- Thermal resistance can be increased substantially depending on the heat sink design/operating condition, and the maximum possible driving current will decrease accordingly.

Performance Characteristics

Table 3. Bin Code Description

Bin Code		
Luminous Flux [lm] @ $I_F = 350\text{mA}$	Peak Wavelength (nm) @ $I_F = 350\text{mA}$	Forward Voltage (V) @ $I_F = 350\text{mA}$



Luminous Flux [lm]		
@ $I_F = 350\text{mA}$		
Bin Code	Min.	Max.
T	70	80
U1	80	90
U2	90	100
U3	100	115

Peak Wavelength (nm)		
@ $I_F = 350\text{mA}$		
Bin Code	Min.	Max.
RR3	620	625
RR4	625	630
RR5	630	635

Forward Voltage (V)		
@ $I_F = 350\text{mA}$		
Bin Code	Min.	Max.
D	1.95	2.15
E	2.15	2.35
F	2.35	2.55

Characteristics Graph

Color Spectrum (IF=350mA, Ta=25°C, RH30%)

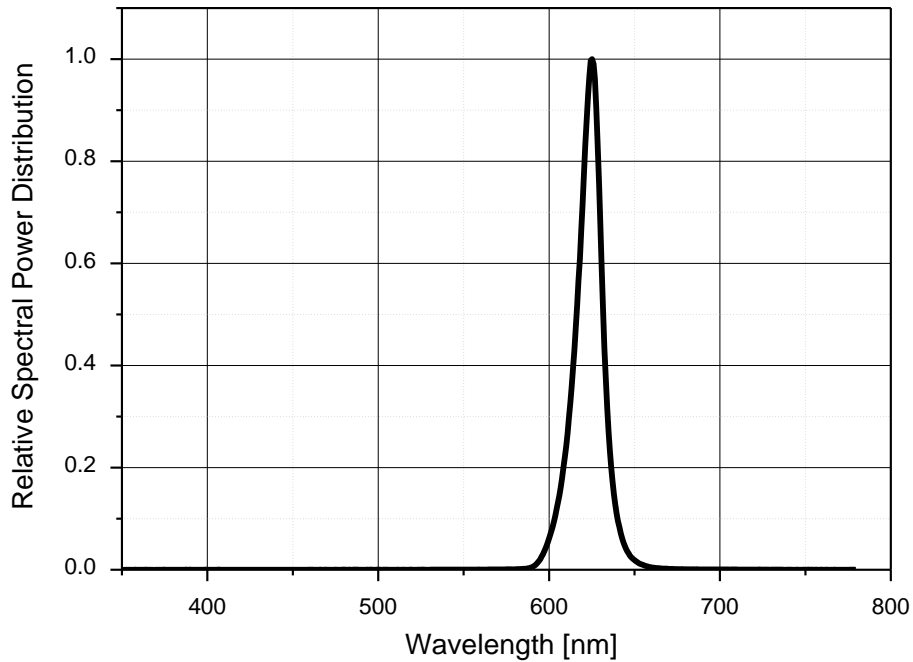

Forward Voltage vs. Forward Current, Ta=25°C

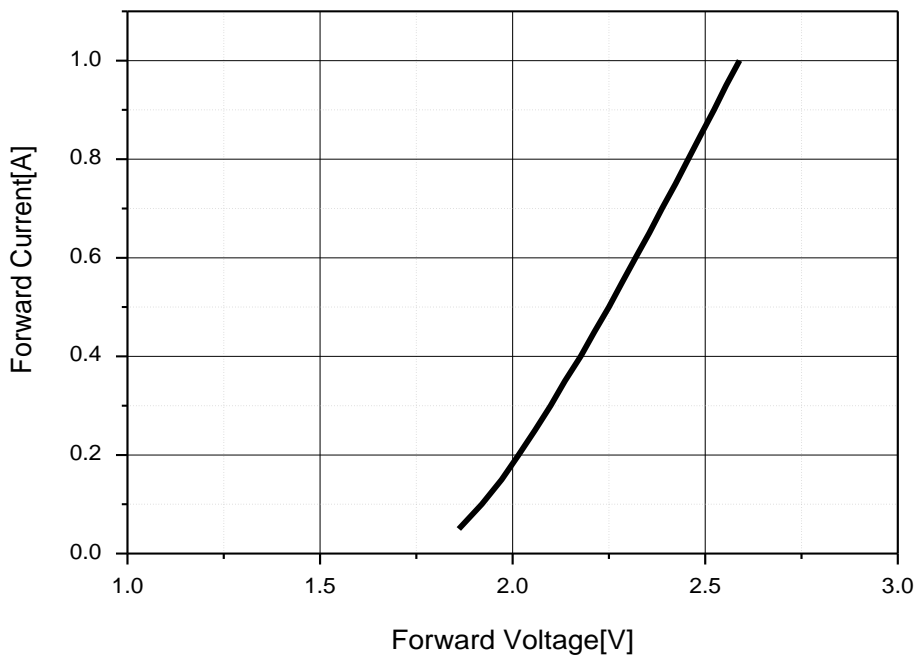

Characteristics Graph

Forward Current vs. Normalized Relative Luminous Flux, Ta=25°C

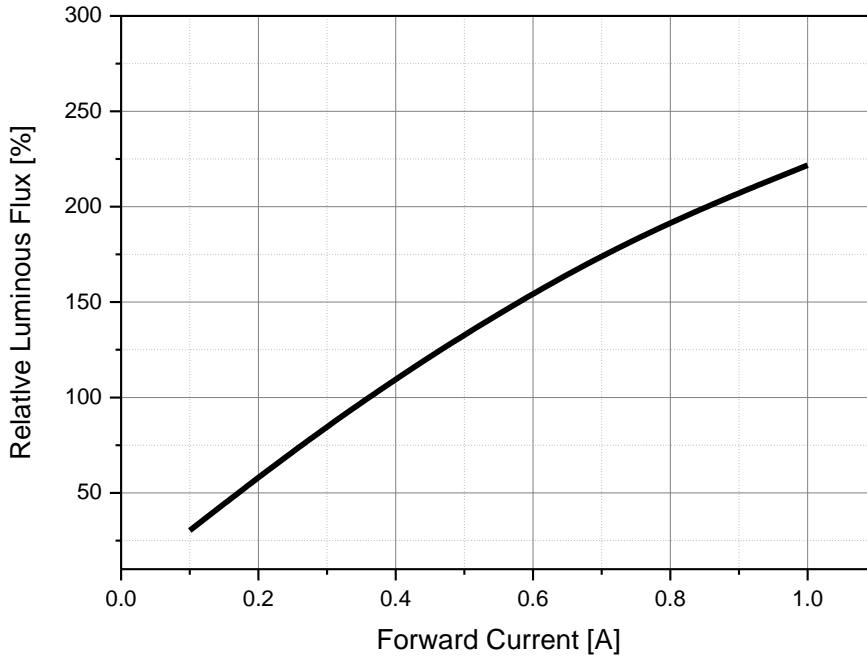

Forward Current vs Peak Wavelength, Ta=25°C

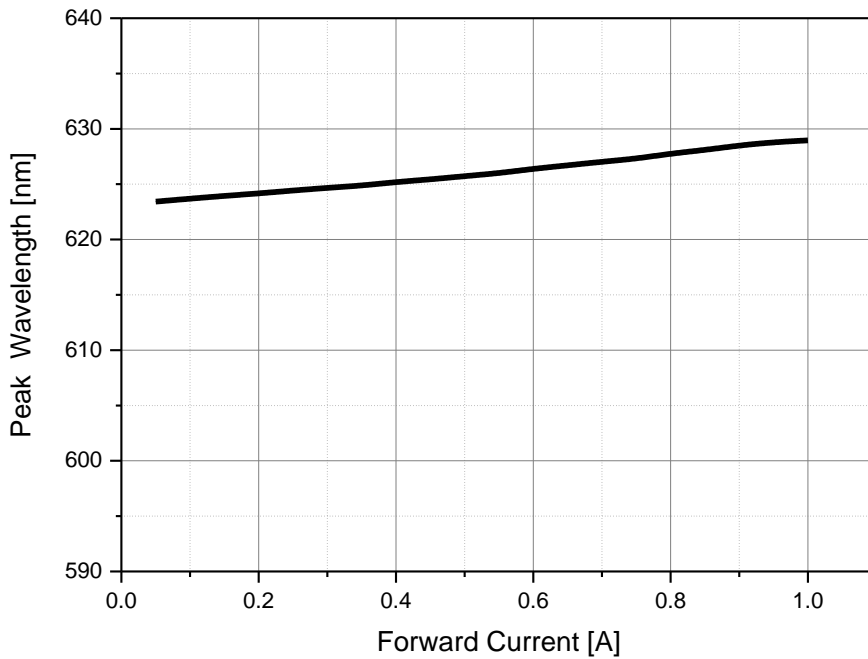

Characteristics Graph

Junction Temperature vs. Relative Light Output at IF=350mA

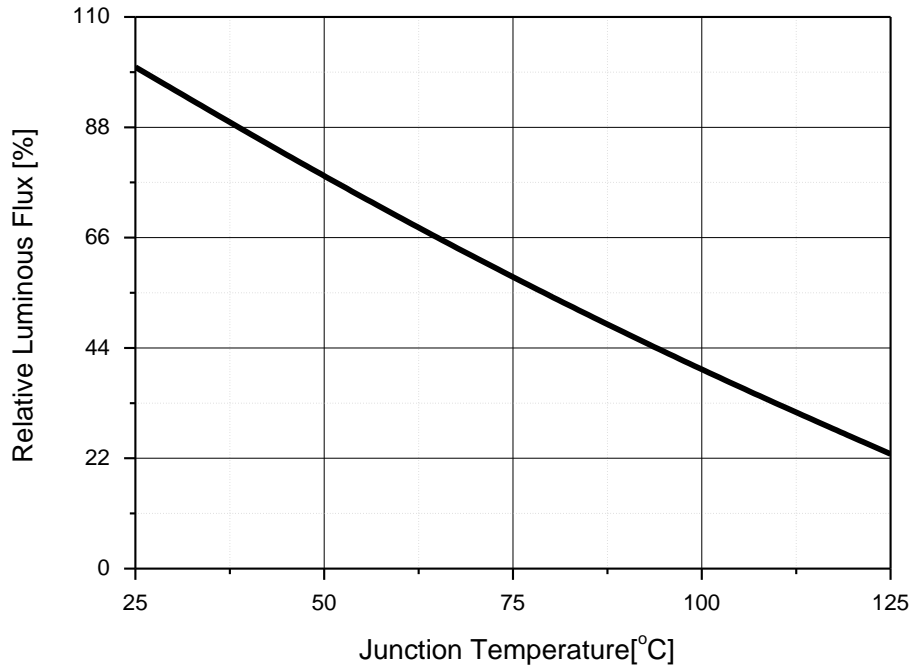

Junction Temperature vs. Relative Forward Voltage at IF=350mA

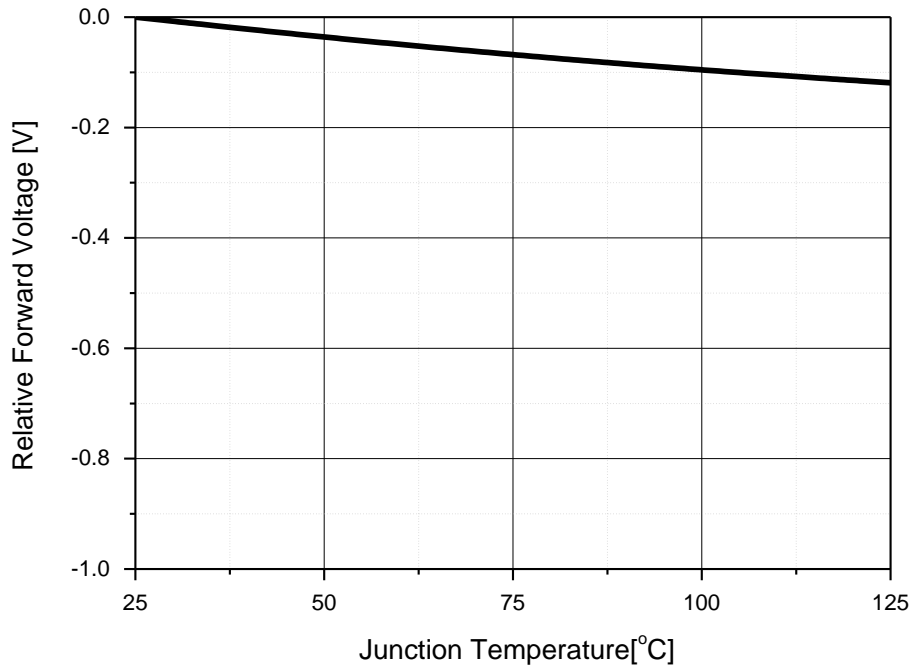

Characteristics Graph

Junction Temperature vs. Peak Wavelength at IF=350mA

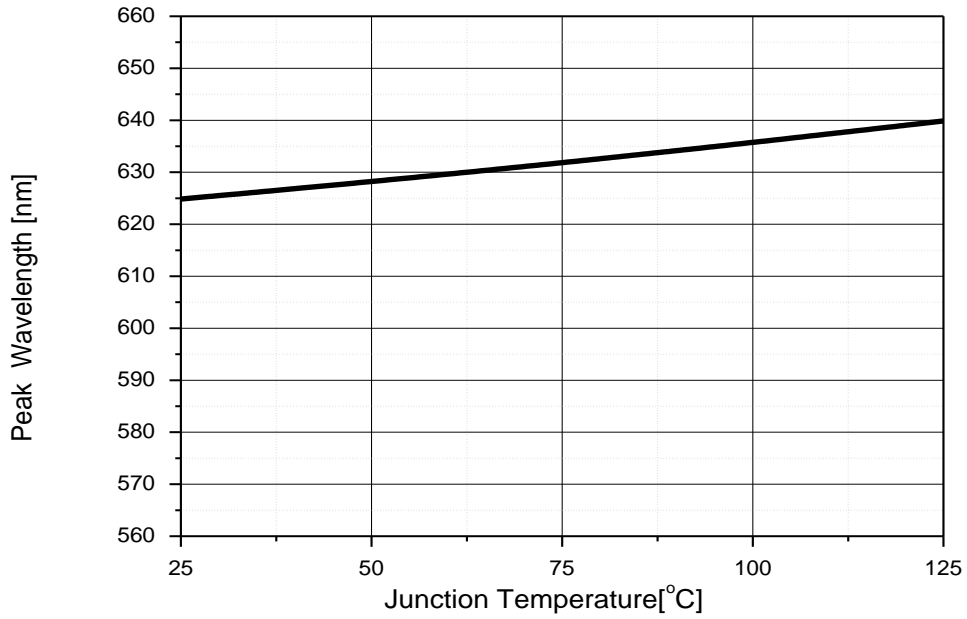

Mechanical Dimensions

Top View

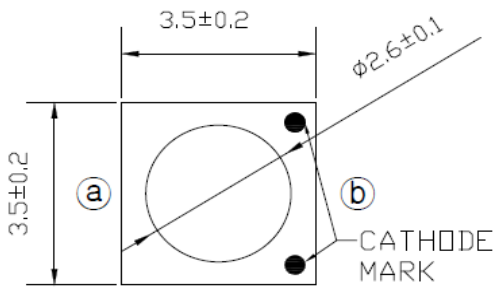

Bottom View

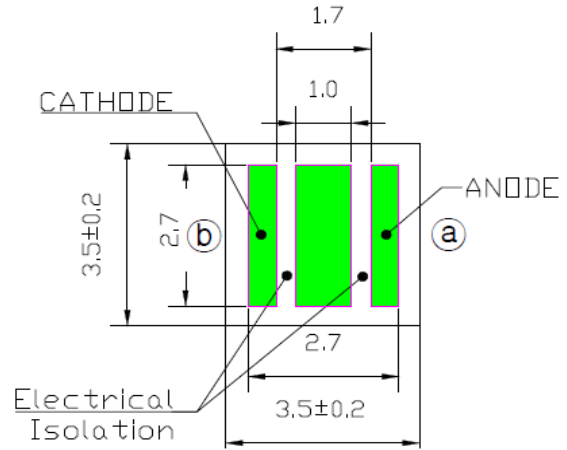

Side View

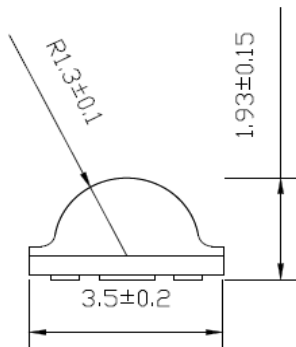

Circuit

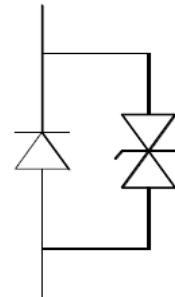

- (1) All dimensions are in millimeters.
- (2) Scale : none
- (3) Undefined tolerance is $\pm 0.1\text{mm}$

Recommended Solder Pad

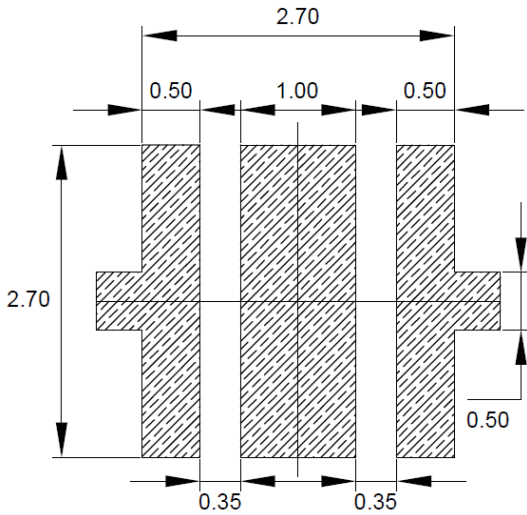
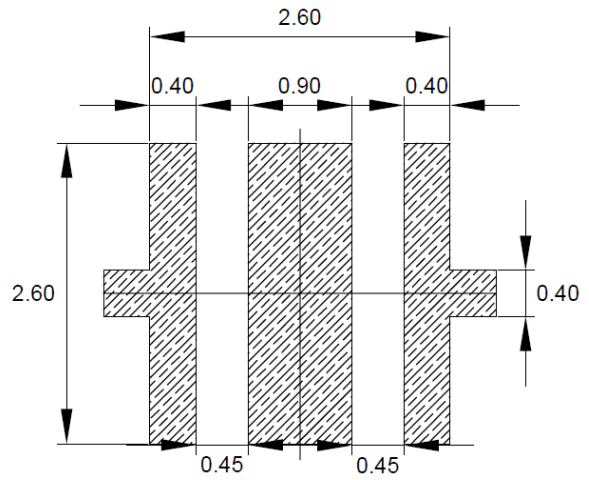
Recommended PCB Solder Pad

Recommended Stencil Pattern

- (1) All dimensions are in millimeters.
- (2) Scale : none
- (3) This drawing without tolerances are for reference only.
- (4) Undefined tolerance is $\pm 0.1\text{mm}$.

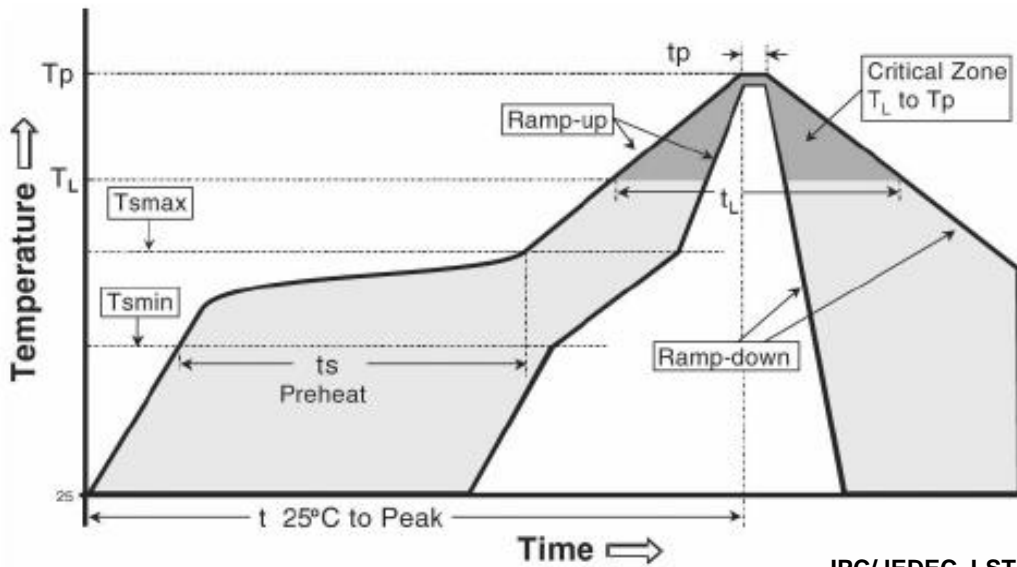
Reflow Soldering Characteristics

IPC/JEDEC J-STD-020

Profile Feature	Sn-Pb Eutectic Assembly	Pb-Free Assembly
Average ramp-up rate (T _{max} to T _p)	3° C/second max.	3° C/second max.
Preheat		
- Temperature Min (T _{min})	100 °C	150 °C
- Temperature Max (T _{max})	150 °C	200 °C
- Time (T _{min} to T _{max}) (t _s)	60-120 seconds	60-180 seconds
Time maintained above:		
- Temperature (T _L)	183 °C	217 °C
- Time (t _L)	60-150 seconds	60-150 seconds
Peak Temperature (T _p)	215°C	260°C
Time within 5°C of actual Peak Temperature (t _p) ²	10-30 seconds	20-40 seconds
Ramp-down Rate	6 °C/second max.	6 °C/second max.
Time 25°C to Peak Temperature	6 minutes max.	8 minutes max.

Caution

- (1) Reflow soldering is recommended not to be done more than two times. In the case of more than 24 hours passed soldering after first, LED will be damaged.
- (2) Repairs should not be done after the LED have been soldered. When repair is unavoidable, suitable tools must be used.
- (3) Die slug is to be soldered.
- (4) When soldering, do not put stress on the LED during heating.
- (5) After soldering, do not warp the circuit board.

Emitter Tape & Reel Packaging

Labeling



Full code form

$X_1X_2X_3X_4X_5X_6X_7X_8$

- X_1 : Company
- X_2 : Z-Power LED series number
- $X_3 X_4$: Color Specification
- X_5 : PKG Series
- X_6 : Lens Type
- X_7 : PCB Type
- X_8 : Revision No.

Rank

$X_{10}X_{11}X_{12}X_{13}$

- $X_{10} X_{11}$: Radiant Power [mW]
- $X_{12}X_{13}X_{14}$: Dominant or Peak Wavelength [nm]
- X_{15} : Forward Voltage : V_F [V]

Lot No

$\#1\#2\#3\#4\#5\#6 - \#7\#8\#9\#10 - \#11\#12\#13$

- $\#_1 \#_2$: Year
- $\#_3 \#_4$: Month
- $\#_5 \#_6$: Day
- $\#_7 \#_8 \#_9 \#_{10}$: Mass order
- $\#_{11} \#_{12} \#_{13}$: Tray No.

Emitter Tape & Reel Packaging

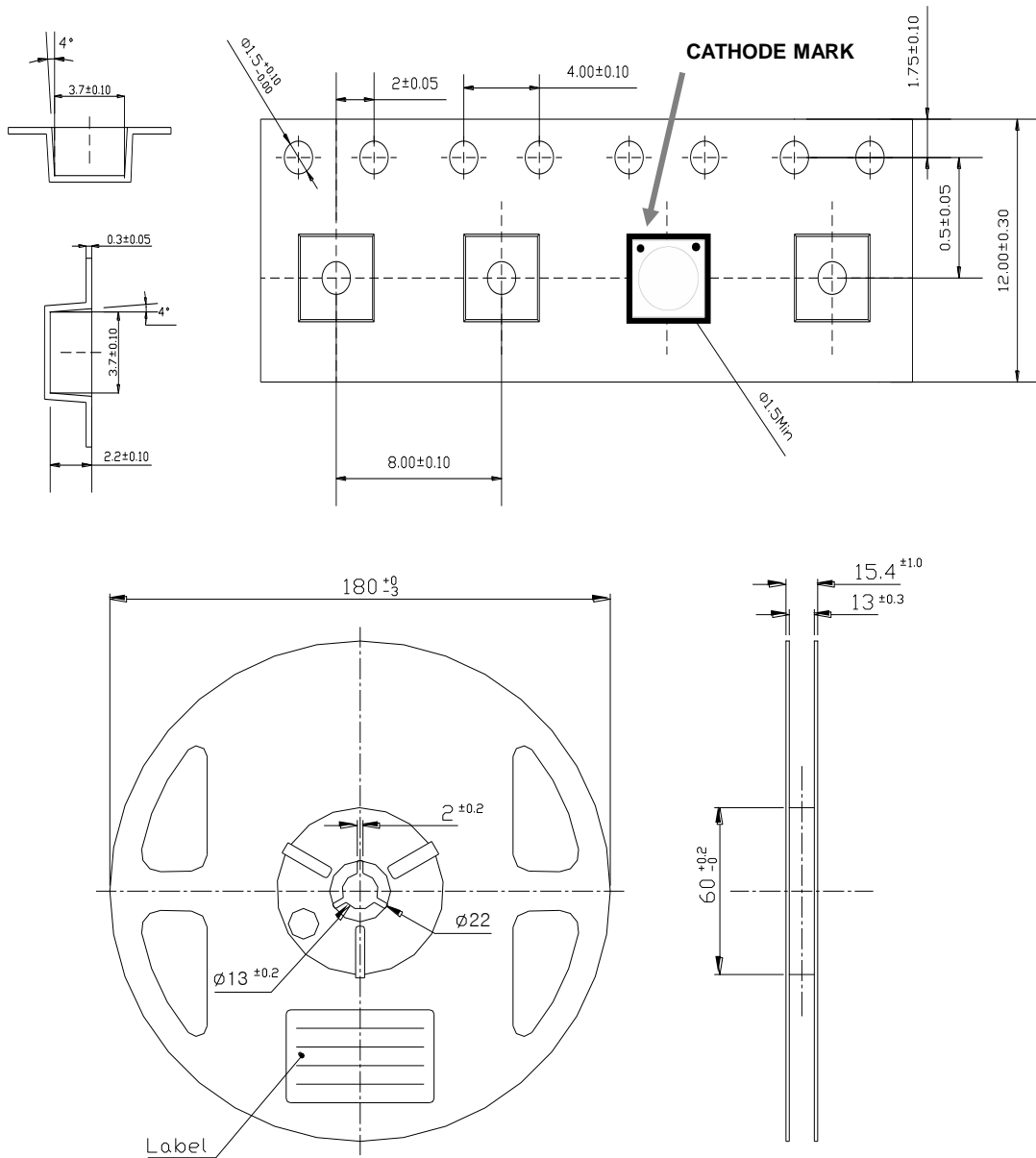
Notes :

1. Quantity : 1000pcs/Reel
2. Cumulative Tolerance : Cumulative Tolerance/10 pitches to be $\pm 0.2\text{mm}$
3. Adhesion Strength of Cover Tape : Adhesion strength to be 10-60g when the cover tape is turned off from the carrier tape at the angle of 10° to the carrier tape
4. Package : P/N, Manufacturing data Code No. and quantity to be indicated on a damp proof Package

Packaging Information

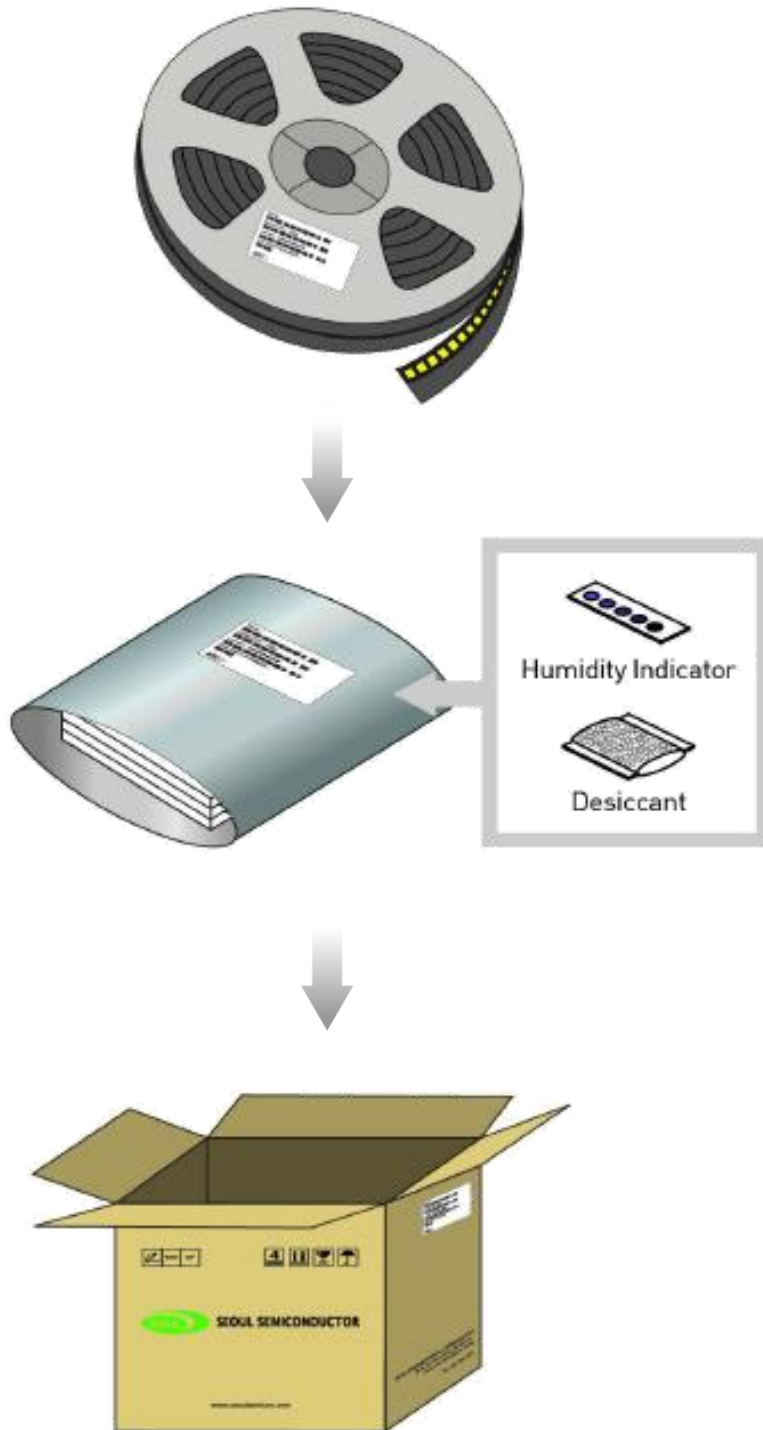

Product Nomenclature

Part Numbering System

Part Number Code	Description	Part Number	Value
X ₁	Company	S	Seoul Semiconductor
X ₂	Level of Integration	1	Discrete LED
X ₃ X ₄	Technology	CH	Color Horticulture
X ₅ X ₆ X ₇ X ₈	Dimension	3535	
X ₉ X ₁₀	Wavelength	62	(X10) nm
X ₁₁ X ₁₂	CRI	-	
X ₁₃ X ₁₄	Vf	03	
X ₁₅ X ₁₆ X ₁₇	Characteristic code Flux Rank	000	
X ₁₈ X ₁₉ X ₂₀	Characteristic code Vf Rank	000	
X ₂₁ X ₂₂	Characteristic code Color Step	00	
X ₂₃ X ₂₄	Type	00	
X ₂₅ X ₂₆ X ₂₇	Internal code	001	

Handling of Silicone Resin for LED

- (1) During processing, mechanical stress on the surface should be minimized as much as possible. Sharp objects of all types should not be used to pierce the sealing compound.

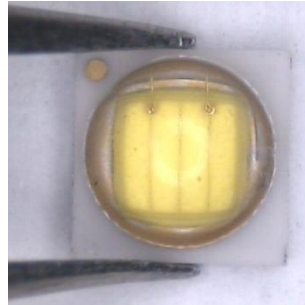
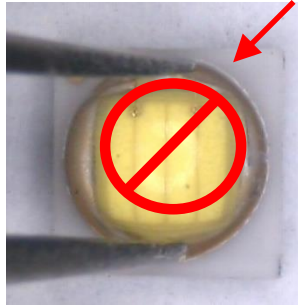

- (2) In general, LED should only be handled from the side. By the way, this also applies to LED without a silicone sealant, since the surface can also become scratched.
- (3) When populating boards in SMT production, there are basically no restrictions regarding the form of the pick and place nozzle, except that mechanical pressure on the surface of the resin must be prevented. This is assured by choosing a pick and place nozzle which is larger than the LED's reflector area.
- (4) Silicone differs from materials conventionally used for the manufacturing of LEDs. These conditions must be considered during the handling of such devices. Compared to standard encapsulants, silicone is generally softer, and the surface is more likely to attract dust. As mentioned previously, the increased sensitivity to dust requires special care during processing. In cases where a minimal level of dirt and dust particles cannot be guaranteed, a suitable cleaning solution must be applied to the surface after the soldering of components.
- (5) Seoul Semiconductor suggests using isopropyl alcohol for cleaning. In case other solvents are used, it must be assured that these solvents do not dissolve the package or resin. Ultrasonic cleaning is not recommended. Ultrasonic cleaning may cause damage to the LED.
- (6) Please do not mold this product into another resin (epoxy, urethane, etc) and do not handle this product with acid or sulfur material in sealed space.
- (7) Avoid leaving fingerprints on silicone resin parts.

Precaution for Use

(1) Storage

To avoid the moisture penetration, we recommend storing Z5 Series LED in a dry box with a desiccant. The recommended storage temperature range is 5°C to 30°C and a maximum humidity of RH50%.

(2) Use Precaution after Opening the Packaging

Use SMT techniques properly when you solder the LED as separation of the lens may affect the light output efficiency.

Pay attention to the following:

a. Recommend conditions after opening the package

- Sealing / Temperature : 5 ~ 40°C Humidity : less than RH30%

b. If the package has been opened more than 4 weeks (MSL 2a) or the color of the desiccant changes, components should be dried for 10-12hr at 60±5°C

(3) Do not apply mechanical force or excess vibration during the cooling process to normal temperature after soldering.

(4) Do not rapidly cool device after soldering.

(5) Components should not be mounted on warped (non coplanar) portion of PCB.

(6) Radioactive exposure is not considered for the products listed here in.

(7) Gallium arsenide is used in some of the products listed in this publication. These products are dangerous if they are burned or shredded in the process of disposal. It is also dangerous to drink the liquid or inhale the gas generated by such products when chemically disposed of.

(8) This device should not be used in any type of fluid such as water, oil, organic solvent and etc. When washing is required, IPA (Isopropyl Alcohol) should be used.

(9) When the LED are in operation the maximum current should be decided after measuring the package temperature.

(10) The appearance and specifications of the product may be modified for improvement without notice.

(11) Long time exposure of sunlight or occasional UV exposure will cause lens discoloration.

Precaution for Use

(12) VOCs (Volatile organic compounds) emitted from materials used in the construction of fixtures can penetrate silicone encapsulants of LED and discolor when exposed to heat and photonic energy. The result can be a significant loss of light output from the fixture. Knowledge of the properties of the materials selected to be used in the construction of fixtures can help prevent these issues.

(13) Attaching LEDs, do not use adhesives that outgas organic vapor.

(14) The driving circuit must be designed to allow forward voltage only when it is ON or OFF. If the reverse voltage is applied to LED, migration can be generated resulting in LED damage.

(15) LED is sensitive to Electro-Static Discharge (ESD) and Electrical Over Stress (EOS). Below is a list of suggestions that Seoul Semiconductor purposes to minimize these effects.

a. ESD (Electro Static Discharge)

Electrostatic discharge (ESD) is defined as the release of static electricity when two objects come into contact. While most ESD events are considered harmless, it can be an expensive problem in many industrial environments during production and storage. The damage from ESD to an LED may cause the product to demonstrate unusual characteristics such as:

- Increase in reverse leakage current lowered turn-on voltage
- Abnormal emissions from the LED at low current

The following recommendations are suggested to help minimize the potential for an ESD event.

One or more recommended work area suggestions:

- Ionizing fan setup
- ESD table/shelf mat made of conductive materials
- ESD safe storage containers

One or more personnel suggestion options:

- Antistatic wrist-strap
- Antistatic material shoes
- Antistatic clothes

Environmental controls:

- Humidity control (ESD gets worse in a dry environment)

Precaution for Use

b. EOS (Electrical Over Stress)

Electrical Over-Stress (EOS) is defined as damage that may occur when an electronic device is subjected to a current or voltage that is beyond the maximum specification limits of the device. The effects from an EOS event can be noticed through product performance like:

- Changes to the performance of the LED package
(If the damage is around the bond pad area and since the package is completely encapsulated the package may turn on but flicker show severe performance degradation.)
- Changes to the light output of the luminaire from component failure
- Components on the board not operating at determined drive power

Failure of performance from entire fixture due to changes in circuit voltage and current across total circuit causing trickle down failures. It is impossible to predict the failure mode of every LED exposed to electrical overstress as the failure modes have been investigated to vary, but there are some common signs that will indicate an EOS event has occurred:

- Damaged may be noticed to the bond wires (appearing similar to a blown fuse)
- Damage to the bond pads located on the emission surface of the LED package
(shadowing can be noticed around the bond pads while viewing through a microscope)
- Anomalies noticed in the encapsulation and phosphor around the bond wires.
- This damage usually appears due to the thermal stress produced during the EOS event.

c. To help minimize the damage from an EOS event Seoul Semiconductor recommends utilizing:

- A surge protection circuit
- An appropriately rated over voltage protection device
- A current limiting device



Company Information

Published by

Seoul Semiconductor © 2013 All Rights Reserved.

Company Information

Seoul Semiconductor (www.SeoulSemicon.com) manufactures and packages a wide selection of light emitting diodes (LEDs) for the automotive, general illumination/lighting, Home appliance, signage and back lighting markets. The company is the world's fifth largest LED supplier, holding more than 10,000 patents globally, while offering a wide range of LED technology and production capacity in areas such as "nPola", "Acrich", the world's first commercially produced AC LED, and "Acrich MJT - Multi-Junction Technology" a proprietary family of high-voltage LEDs.

The company's broad product portfolio includes a wide array of package and device choices such as Acrich and Acirch2, high-brightness LEDs, mid-power LEDs, side-view LEDs, and through-hole type LED as well as custom modules, displays, and sensors.

Legal Disclaimer

Information in this document is provided in connection with Seoul Semiconductor products. With respect to any examples or hints given herein, any typical values stated herein and/or any information regarding the application of the device, Seoul Semiconductor hereby disclaims any and all warranties and liabilities of any kind, including without limitation, warranties of non-infringement of intellectual property rights of any third party. The appearance and specifications of the product can be changed to improve the quality and/or performance without notice.