



# HLC CHIP MULTILAYER CERAMIC CAPACITORS General Purpose Series (4V to 4000V)

## HOW TO ORDER

HLC	1206	X7R	104	K	500	N	-
↓	↓	↓	↓	↓	↓	↓	↓
Type	Size	Dielectric	Capacitance	Tolerance	Rated voltage	Termination	Additional characters may be added for special requirements
HLC	Inch (mm) 0201 (0603) 0402 (1005) 0603 (1608) 0805 (2012) 1206 (3216) 1210 (3225) 1808 (4520) 1812 (4532) 1825 (4563) 2211 (5728) 2220 (5750) 2225 (5763)	NPO X7R Y5V X5R	Two significant digits followed by no. of zeros. And R is in place of decimal point.  eg.: 0R5=0.5pF 1R0=1.0pF 104=10x104=100nF	A=±0.05pF B=±0.1pF C=±0.25pF D=±0.5pF F=±1% G=±2% J=±5% K=±10% M=±20% Z=-20/+80%	Two significant digits followed by no. of zeros. And R is in place of decimal point.  4R0=4 VDC 6R3=6.3 VDC 100=10 VDC 160=16 VDC 250=25 VDC 500=50 VDC 101=100 VDC 102=1000 VDC 202= 2000 VDC	N=Cu/Ni/Sn	

## The Outlines and External Dimensions of Capacitors

Outline	Size Inch (mm)	L (mm)	W (mm)	T (mm)/Symbol	Soldering Method *	M <sub>B</sub> (mm)		
	01R5 (0402)	0.4±0.02	0.2±0.02	0.2±0.02	V	R	0.10±0.03	
	0201 (0603)	0.6±0.03	0.3±0.03	0.3±0.03	L	R	0.15±0.05	
		0.6±0.05 <sup>#2</sup>	0.3±0.05 <sup>#2</sup>	0.3±0.05 <sup>#2</sup>			0.15±0.1/-0.05	
		0.6±0.09 <sup>#3</sup>	0.3±0.09 <sup>#3</sup>	0.3±0.09 <sup>#3</sup>				
	0402 (1005)	1.00±0.05	0.50±0.05	0.50±0.05	N	R	0.25 +0.05/-0.10	
		1.00±0.20	0.50±0.20	0.50+0.02/-0.05	Q	R		
				0.5±0.20	E	R		
	0603 (1608)	1.60±0.10	0.80±0.10	0.80±0.07	S	R / W	0.40±0.15	
				0.50±0.10	H	R / W		
				0.80+0.15/-0.10	X	R / W		
	0805 (2012)	2.00±0.15	1.25±0.10	0.50±0.10	H	R / W	0.50±0.20	
				0.60±0.10	A	R / W		
				0.80±0.10	B	R / W		
				1.25±0.10	D	R		
				0.85±0.10	T	R / W		
	1206 (3216)	3.20±0.20	1.60±0.20	1.25±0.20	I	R	0.60±0.20 (0.5±0.25) <sup>***</sup>	
				0.80±0.10	B	R / W		
				0.95±0.10	C	R		
				1.25±0.10	D	R		
				1.15±0.15	J	R		
1210 (3225)	3.20±0.40	2.50±0.30	1.60±0.20	G	R	0.75±0.25		
			2.00±0.20	K	R			
			2.50±0.30	M	R			
			3.20+0.30/-0.10				1.60+0.30/-0.10	P
			1.60±0.20				R	
1808 (4520)	4.50±0.40 (4.5±0.5/-0.3) <sup>**</sup>	2.03±0.25	0.95±0.10	C	R	0.75±0.25 (0.5±0.25) <sup>***</sup>		
			0.85±0.10	T	R			
			1.25±0.10	D	R			
			1.60±0.20	G	R			
			2.00±0.20	K	R			
1812 (4532)	4.50±0.40 (4.5±0.5/-0.3) <sup>**</sup>	3.20±0.30	1.25±0.10	D	R	0.75±0.25 (0.5±0.25) <sup>***</sup>		
			1.60±0.20	G	R			
			2.00±0.20	K	R			
			2.50±0.30	M	R			
			2.80±0.30	U	R			
1825 (4563)	4.60±0.50	6.30±0.40	1.60±0.20 (G)	2.00±0.20 (K)	R	≧0.26		
2211 (5728)	5.70±0.50	2.80±0.30			R	≧0.30		
2220 (5750)	5.70±0.50	5.00±0.40	2.50±0.30 (M)		R	≧0.30		
2225 (5763)	5.70±0.50	6.30±0.40	2.80±0.30 (U)		R	≧0.30		

\* R = Reflow soldering process ; W = Wave soldering process.

\*\* For 1808\_200V ~3kV, 1812\_200V~3kV

\*\*\* For 1206\_1000V ~3kV, 1808\_200V ~3kV, 1812\_200V~3kV

#1 : For 0603/Cap ≧ 10µF or 0603(≧6.3V)/Cap ≧ 4.7µ For 0603(>10V)/Cap > 1µF products.

#2 : For 0201/Cap ≧ 0.68µF products.

#3 : For 0201/Cap ≧ 1µF products.

#4 : For 1210(100V)/ Cap > 1µ F or 1210(250V)/Cap > 0.47µ F or 1210(400V~630V)/Cap > 0.22µ F.

## DESCRIPTION

MLCC consists of a conducting material and electrodes. To manufacture a chip-type SMT and achieve miniaturization, high density and high efficiency, ceramic condensers are used.

MLCC is made by NP0, X7R, X5R and Y5V dielectric material and which provides product with high electrical precision, stability and reliability.

## FEATURES

- \* A wide selection of sizes is available (0201 to 2225).
- \* High capacitance in given case size.
- \* RoHS REACH Compliance

## APPLICATIONS

- a. For general digital circuit.
- b. For power supply bypass capacitors.
- c. For consumer electronics.
- d. For telecommunication.

## ■ GENERAL ELECTRICAL DATA

Dielectric	NP0	X7R	X5R	Y5V
Size	0201, 0402, 0603, 0805, 1206, 1210, 1812, 1825, 2220, 2225			
Capacitance range	0.1pF to 0.27μF	100pF to 47μF	100pF to 220μF	0.01μF to 100μF
Capacitance tolerance	Cap≤5pF <sup>#1</sup> : A (±0.05pF), B (±0.1pF), C (±0.25pF) 5pF<Cap<10pF: C (±0.25pF), D (±0.5pF) Cap≥10pF: F(±1%), G (±2%), J (±5%), K (±10%)	J (±5%), K (±10%), M (±20%)	K (±10%), M (±20%)	M (±20%), Z (-20/+80%)
Rated voltage (WVDC)	10V, 16V, 25V, 50V, 100V	4V, 6.3V, 10V, 16V, 25V, 50V, 100V		
Operating temperature	-55 to +125°C		-55 to +85°C	-25 to +85°C
Capacitance characteristic	±30ppm	±15%	±15%	+30/-80%
Termination	Ni/Sn (lead-free termination)			

#1: NP0, 0.1pF product only provide B tolerance

## ■ ELECTRICAL CHARACTERISTICS

### 1) Frequency characteristics

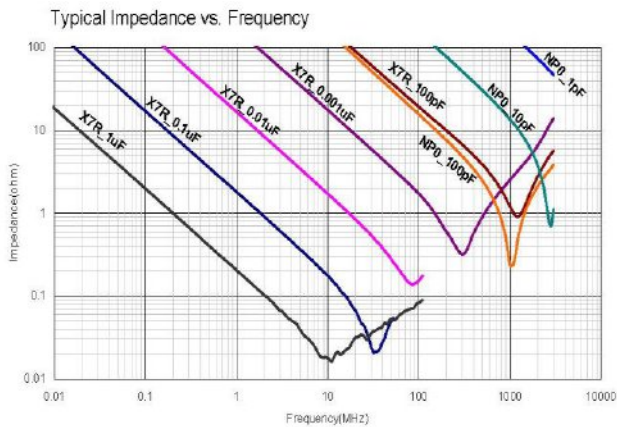

### 2) Capacitance Change - Typical aging rate

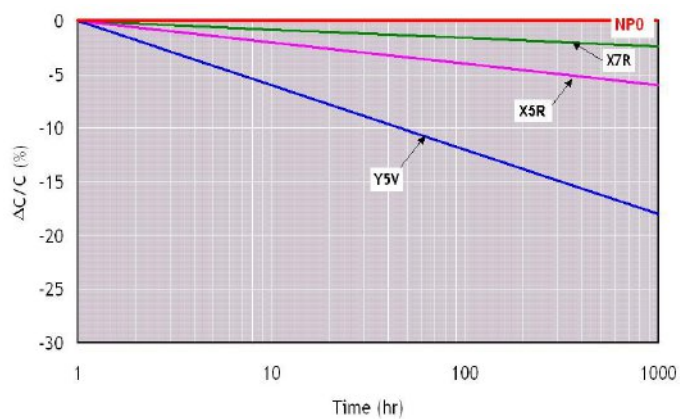

### 3) Temperature characteristics of capacitance (TCC)

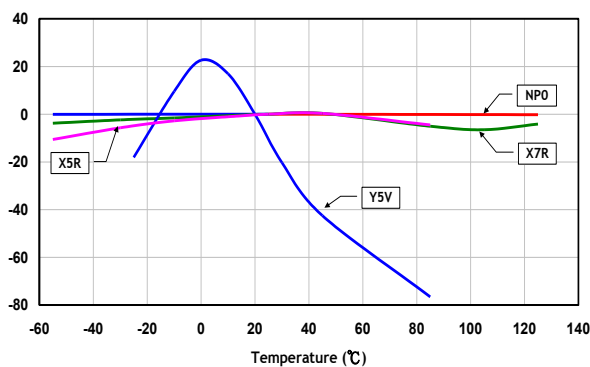

### 4) DC Bias characteristics

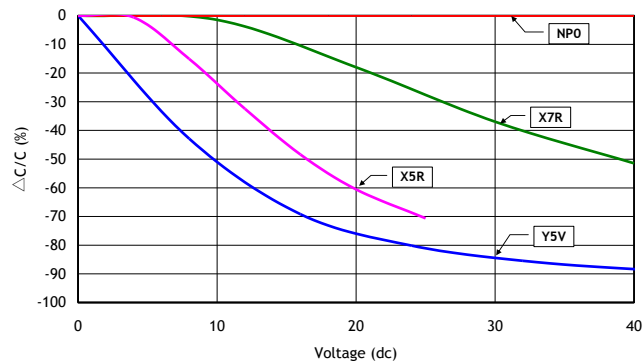

All above typical electronic characteristics are for reference only.



■ CAPACITANCE RANGE

NP0 Dielectric

Dielectric		NP0																						
Size	0201		0402		0603		0805			1206			1210			1812		1825		2220		2225		
Rated Voltage (VDC)	16 25	50	10 16 25 50	100	10 16 25 50	100	10 16	25 50	100	10 16	25 50	100	10 16	25 50	100	10 16 25 50	100	50	100	50	100	50	100	
0.3pF (0R3)	L	L	N		S																			
0.4pF (0R4)	L	L	N		S																			
0.5pF (0R5)	L	L	N	N	S	S	A	A	A															
0.6pF (0R6)	L	L	N	N	S	S	A	A	A															
0.7pF (0R7)	L	L	N	N	S	S	A	A	A															
0.8pF (0R8)	L	L	N	N	S	S	A	A	A															
0.9pF (0R9)	L	L	N	N	S	S	A	A	A															
1.0pF (1R0)	L	L	N	N	S	S	A	A	A															
1.2pF (1R2)	L	L	N	N	S	S	A	A	A	B	B	B												
1.5pF (1R5)	L	L	N	N	S	S	A	A	A	B	B	B												
1.8pF (1R8)	L	L	N	N	S	S	A	A	A	B	B	B												
2.0pF (2R0)	L	L	N	N	S	S	A	A	A	B	B	B												
2.2pF (2R2)	L	L	N	N	S	S	A	A	A	B	B	B												
2.7pF (2R7)	L	L	N	N	S	S	A	A	A	B	B	B												
3.0pF (3R0)	L	L	N	N	S	S	A	A	A	B	B	B												
3.3pF (3R3)	L	L	N	N	S	S	A	A	A	B	B	B												
3.9pF (3R9)	L	L	N	N	S	S	A	A	A	B	B	B												
4.0pF (4R0)	L	L	N	N	S	S	A	A	A	B	B	B												
4.7pF (4R7)	L	L	N	N	S	S	A	A	A	B	B	B												
5.0pF (5R0)	L	L	N	N	S	S	A	A	A	B	B	B												
5.6pF (5R6)	L	L	N	N	S	S	A	A	A	B	B	B												
6.0pF (6R0)	L	L	N	N	S	S	A	A	A	B	B	B												
6.8pF (6R8)	L	L	N	N	S	S	A	A	A	B	B	B												
7.0pF (7R0)	L	L	N	N	S	S	A	A	A	B	B	B												
8.0pF (8R0)	L	L	N	N	S	S	A	A	A	B	B	B												
8.2pF (8R2)	L	L	N	N	S	S	A	A	A	B	B	B												
9.0pF (9R0)	L	L	N	N	S	S	A	A	A	B	B	B												
10pF (100)	L	L	N	N	S	S	A	A	A	B	B	B	C	C	C	D	D	G	G	G	G	G	G	G
12pF (120)	L	L	N	N	S	S	A	A	A	B	B	B	C	C	C	D	D	G	G	G	G	G	G	G
15pF (150)	L	L	N	N	S	S	A	A	A	B	B	B	C	C	C	D	D	G	G	G	G	G	G	G
18pF (180)	L	L	N	N	S	S	A	A	A	B	B	B	C	C	C	D	D	G	G	G	G	G	G	G
22pF (220)	L	L	N	N	S	S	A	A	A	B	B	B	C	C	C	D	D	G	G	G	G	G	G	G
27pF (270)	L	L	N	N	S	S	A	A	A	B	B	B	C	C	C	D	D	G	G	G	G	G	G	G
33pF (330)	L	L	N	N	S	S	A	A	A	B	B	B	C	C	C	D	D	G	G	G	G	G	G	G
39pF (390)	L	L	N	N	S	S	A	A	A	B	B	B	C	C	C	D	D	G	G	G	G	G	G	G
47pF (470)	L	L	N	N	S	S	A	A	A	B	B	B	C	C	C	D	D	G	G	G	G	G	G	G
56pF (560)	L	L	N	N	S	S	A	A	A	B	B	B	C	C	C	D	D	G	G	G	G	G	G	G
68pF (680)	L	L	N	N	S	S	A	A	A	B	B	B	C	C	C	D	D	G	G	G	G	G	G	G
82pF (820)	L	L	N	N	S	S	A	A	A	B	B	B	C	C	C	D	D	G	G	G	G	G	G	G
100pF (101)	L	L	N	N	S	S	A	A	A	B	B	B	C	C	C	D	D	G	G	G	G	G	G	G
120pF (121)	L	L	N	N	S	S	A	A	A	B	B	B	C	C	C	D	D	G	G	G	G	G	G	G
150pF (151)	L	L	N	N	S	S	A	A	A	B	B	B	C	C	C	D	D	G	G	G	G	G	G	G
180pF (181)			N	N	S	S	A	A	A	B	B	B	C	C	C	D	D	G	G	G	G	G	G	G
220pF (221)			N	N	S	S	A	A	A	B	B	B	C	C	C	D	D	G	G	G	G	G	G	G
270pF (271)	L		N		S	S	A	A	A	B	B	B	C	C	C	D	D	G	G	G	G	G	G	G
330pF (331)	L		N		S	S	A	A	A	B	B	B	C	C	C	D	D	G	G	G	G	G	G	G
390pF (391)	L		N		S	S	B	B	B	B	B	B	C	C	C	D	D	G	G	G	G	G	G	G
470pF (471)	L		N		S	S	B	B	B	B	B	B	C	C	C	D	D	G	G	G	G	G	G	G
560pF (561)	L		N		S	S	B	B	B	B	B	B	C	C	C	D	D	G	G	G	G	G	G	G
680pF (681)			N		S	S	B	B	B	B	B	B	C	C	C	D	D	G	G	G	G	G	G	G
820pF (821)			N		S	S	B	B	B	B	B	B	C	C	C	D	D	G	G	G	G	G	G	G
1,000pF (102)			N		S	S	B	B	B	B	B	B	C	C	C	D	D	G	G	G	G	G	G	G
1,200pF (122)					X	X	B	B	B	B	B	B	C	C	C	D	D	G	G	G	G	G	G	G
1,500pF (152)					X	X	B	B	B	B	B	B	C	C	C	D	D	G	G	G	G	G	G	G
1,800pF (182)					X		B	B	B	B	B	B	C	C	C	D	D	G	G	G	G	G	G	G
2,200pF (222)					X		B	B	B	B	B	B	C	C	C	D	D	G	G	G	G	G	G	G
2,700pF (272)					X		D	D	D	B	B	B	C	C	C	D	D	G	G	G	G	G	G	G
3,300pF (332)					X		D	D	D	B	B	B	C	C	C	D	D	G	G	G	G	G	G	G
3,900pF (392)					X		D	D	D	B	B	B	C	C	C	D	D	G	G	G	G	G	G	G
4,700pF (472)					X		D	D	D	B	B	B	C	C	C	D	D	G	G	G	G	G	G	G
5,600pF (562)					X		D	D	D	B	B	B	C	C	C	D	D	G	G	G	G	G	G	G
6,800pF (682)					X		D	D	D	C	C	C	C	C	C	D	D	G	G	G	G	G	G	G
8,200pF (822)					X		D	D	D	D	D	D	C	C	C	D	D	G	G	G	G	G	G	G
0.010uF (103)					X		D	D	D	D	D	D	C	C	C	D	D	G	G	G	G	G	G	G
0.012uF (123)							T	T		P	P	P	D	D	D	D	D	G	G	G	G	G	G	G
0.015uF (153)							T	T		P	P	P	D	D	D	D	D	G	G	G	G	G	G	G
0.018uF (183)							D	D		P	P	P	K	K	K	D	D	G	G	G	G	G	G	G
0.022uF (223)							D	D		P	P	P	K	K	K	D	D	G	G	G	G	G	G	G
0.027uF (273)										P	P	P	K	K	K	D	D	G	G	G	G	G	G	G
0.033uF (333)										P	P	T	K	K	K	D	D	G	G	G	G	G	G	G
0.039uF (393)										P	P		K	K	K	M	M	G	G	G	G	G	G	G
0.047uF (473)										J	J		K	K	K	M	M	G	G	G	G	G	G	G
0.056uF (563)										J	J					M	M	G	K	G	K	G	G	G
0.068uF (683)										G	G					M	M	G	K	K	K	G	G	K
0.082uF (823)										G	G					M	M	K	M	M	M	K	K	K
0.10uF (104)										G	G					M	M	M	M	M	M	K	M	M
0.12uF (124)																	M	M	M	M	M	M	M	M
0.15uF (154)																		M	M			M	M	M
0.18uF (184)																					M	M	M	M
0.22uF (224)																						M	M	M
0.27uF (274)																								M

1. The letter in cell is expressed the symbol of product thickness.



X7R Dielectric

Dielectric		X7R																															
Size	0201				0402				0603				0805				1206				1210				1812		1825		2220		2225		
Rated Voltage (VDC)	6.3 10 16	25	50	6.3 10 16	16 25	50	100	6.3 10 16	25	50	100	6.3 10 16	25	50	100	6.3 10 16	25	50	100	10	16	25	50	100	10 16 25	50 100	50 100	25 50	100	25 50	100		
100pF (101)	L	L	L	N	N	N	N	S	S	S	S	B	B	B	B																		
120pF (121)	L	L	L	N	N	N	N	S	S	S	S	B	B	B	B																		
150pF (151)	L	L	L	N	N	N	N	S	S	S	S	B	B	B	B	B	B	B	B														
180pF (181)	L	L	L	N	N	N	N	S	S	S	S	B	B	B	B	B	B	B	B														
220pF (221)	L	L	L	N	N	N	N	S	S	S	S	B	B	B	B	B	B	B	B														
270pF (271)	L	L	L	N	N	N	N	S	S	S	S	B	B	B	B	B	B	B	B														
330pF (331)	L	L	L	N	N	N	N	S	S	S	S	B	B	B	B	B	B	B	B														
390pF (391)	L	L	L	N	N	N	N	S	S	S	S	B	B	B	B	B	B	B	B														
470pF (471)	L	L	L	N	N	N	N	S	S	S	S	B	B	B	B	B	B	B	B														
560pF (561)	L	L	L	N	N	N	N	S	S	S	S	B	B	B	B	B	B	B	B														
680pF (681)	L	L	L	N	N	N	N	S	S	S	S	B	B	B	B	B	B	B	B														
820pF (821)	L	L	L	N	N	N	N	S	S	S	S	B	B	B	B	B	B	B	B														
1,000pF (102)	L	L	L	N	N	N	N	S	S	S	S	B	B	B	B	B	B	B	B	C	C	C	C	C	D	D	K	K	K	K	K	K	
1,200pF (122)	L	L	L	N	N	N	N	S	S	S	S	B	B	B	B	B	B	B	B	C	C	C	C	C	D	D	K	K	K	K	K	K	
1,500pF (152)	L	L	L	N	N	N	N	S	S	S	S	B	B	B	B	B	B	B	B	C	C	C	C	C	D	D	K	K	K	K	K	K	
1,800pF (182)	L	L	L	N	N	N	N	S	S	S	S	B	B	B	B	B	B	B	B	C	C	C	C	C	D	D	K	K	K	K	K	K	
2,200pF (222)	L	L	L	N	N	N	N	S	S	S	S	B	B	B	B	B	B	B	B	C	C	C	C	C	D	D	K	K	K	K	K	K	
2,700pF (272)	L	L	L	N	N	N	N	S	S	S	S	B	B	B	B	B	B	B	B	C	C	C	C	C	D	D	K	K	K	K	K	K	
3,300pF (332)	L	L	L	N	N	N	N	S	S	S	S	B	B	B	B	B	B	B	B	C	C	C	C	C	D	D	K	K	K	K	K	K	
3,900pF (392)	L	L	L	N	N	N	N	S	S	S	S	B	B	B	B	B	B	B	B	C	C	C	C	C	D	D	K	K	K	K	K	K	
4,700pF (472)	L	L	L	N	N	N	N	S	S	S	S	B	B	B	B	B	B	B	B	C	C	C	C	C	D	D	K	K	K	K	K	K	
5,600pF (562)	L	L	L	N	N	N	N	S	S	S	S	B	B	B	B	B	B	B	B	C	C	C	C	C	D	D	K	K	K	K	K	K	
6,800pF (682)	L	L	L	N	N	N	N	S	S	S	S	B	B	B	B	B	B	B	B	C	C	C	C	C	D	D	K	K	K	K	K	K	
8,200pF (822)	L	L	L	N	N	N	N	S	S	S	S	B	B	B	B	B	B	B	B	C	C	C	C	C	D	D	K	K	K	K	K	K	
0.010uF (103)	L	L	L	N	N	N	N	S	S	S	S	B	B	B	B	B	B	B	B	C	C	C	C	C	D	D	K	K	K	K	K	K	
0.012uF (123)				N	N	E		S	S	S	X	B	B	B	B	B	B	B	B	C	C	C	C	C	D	D	K	K	K	K	K	K	
0.015uF (153)				N	N	E		S	S	S	X	B	B	B	B	B	B	B	B	C	C	C	C	C	D	D	K	K	K	K	K	K	
0.018uF (183)				N	N	E		S	S	S	X	B	B	B	B	B	B	B	B	C	C	C	C	C	D	D	K	K	K	K	K	K	
0.022uF (223)	L			N	N	E		S	S	S	X	B	B	B	B	B	B	B	B	C	C	C	C	C	D	D	K	K	K	K	K	K	
0.027uF (273)				N	N	E		S	S	S	X	B	B	B	D	B	B	B	B	C	C	C	C	C	D	D	K	K	K	K	K	K	
0.033uF (333)				N	N	E		S	S	X	X	B	B	B	D	B	B	B	B	C	C	C	C	C	D	D	K	K	K	K	K	K	
0.039uF (393)				N	N	E		S	S	X	X	B	B	B	D	B	B	B	B	C	C	C	C	C	D	D	K	K	K	K	K	K	
0.047uF (473)				N	N	E		S	S	X	X	B	B	B	D	B	B	B	B	C	C	C	C	C	D	D	K	K	K	K	K	K	
0.056uF (563)				N	N	E		S	S	X	X	B	B	B	D	B	B	B	B	C	C	C	C	C	D	D	K	K	K	K	K	K	
0.068uF (683)				N	N	E		S	S	X	X	B	B	B	D	B	B	B	B	C	C	C	C	C	D	D	K	K	K	K	K	K	
0.082uF (823)				N	N	E		S	S	X	X	B	B	B	D	B	B	B	D	C	C	C	C	C	D	D	K	K	K	K	K	K	
0.10uF (104)				N	N	E		S	S	X	X	B	B	B	D	B	B	B	D	C	C	C	C	C	D	D	K	K	K	K	K	K	
0.12uF (124)								S	X			B	B	D	I	B	B	B	D	C	C	C	C	C	D	D	K	K	K	K	K	K	
0.15uF (154)								S	X			D	D	D	I	C	C	C	G	C	C	C	C	D	D	D	K	K	K	K	K	K	
0.18uF (184)								S	X			D	D	D	I	C	C	C	G	C	C	C	C	D	D	D	K	K	K	K	K	K	
0.22uF (224)				N	N			S	X	X		D	D	D	I	C	C	C	G	C	C	C	C	D	D	D	K	K	K	K	K	K	
0.27uF (274)								X	X			D	D	I		C	C	D	G	C	C	C	C	D	D	D	K	K	K	K	K	K	
0.33uF (334)								X	X	X		D	D	I		C	C	D	G	C	C	C	D	G	D	D	K	K	K	K	K	K	
0.39uF (394)								X	X			D	D	I		C	J	P	G	C	C	C	D	M	D	D	K	K	K	K	K	K	
0.47uF (474)				N				X	X	X		D	D	I	I	J	J	P	G	C	C	C	D	M	D	D	K	K	K	K	K	K	
0.56uF (564)								X				D	D			J	J	P	P	D	D	D	D	M	D	D	K	K	K	K	K	K	
0.68uF (684)								X				D	D			J	J	P	P	D	D	D	D	K	D	K	K	K	K	K	K	K	
0.82uF (824)								X				D	D			J	J	P	P	D	D	D	D	K	D	K	K	K	K	K	K	K	
1.0uF (105)				N				X	X	X		D	D	I		J	J	P	P	D	D	D	D	K	D	K	K	K	K	K	K	K	
1.5uF (155)												I	I			J	P			G	G	M	M			K	K	K	K	K	K	K	
2.2uF (225)								X				I	I	I		J	P	P	P	G	G	M	M		M	K	K	K	K	K	K	K	
3.3uF (335)																P	P			G	G	M				K	K	K	K	K	K	K	
4.7uF (475)								X				I	I			P	P	P		K	K	K	M	M			K	K	M	K			
6.8uF (685)																												M	U	M			
10uF (106)												I	I			P	P			K	K	K	M					U	U	U			
22uF (226)																P				M	M	M											
47uF (476)																				M													

1. The letter in cell is expressed the symbol of product thickness.  
 2. 0402 size, Cap.1.0uF\_6.3V only; 0603 size, Cap.4.7uF\_6.3V only.





X5R Dielectric

Dielectric		X5R																																								
Size		0201					0402					0603					0805					1206					1210															
Rated Voltage (VDC)		6.3	10	16	25	50	6.3	10	16	25	50	6.3	10	16	25	50	6.3	10	16	25	50	6.3	10	16	25	50	6.3	10	16	25	50	4	6.3	10	16	25	50					
Capacitance	100pF (101)	L	L	L	L	L																																				
	220pF (221)	L	L	L	L	L																																				
	470pF (471)	L	L	L	L	L																																				
	1000pF (102)	L	L	L	L	L																																				
	2200pF (222)	L	L	L	L	L																																				
	4700pF (472)	L	L	L	L	L																																				
	0.010µF (103)	L	L	L	L	L																																				
	0.027µF (273)	L	L								N																															
	0.033µF (333)	L	L								N																															
	0.039µF (393)	L	L								N																															
	0.047µF (473)	L	L								N																															
	0.056µF (563)	L	L								N	N																														
	0.068µF (683)	L	L								N	N																														
	0.082µF (823)	L	L								N	N	N																													
	0.10µF (104)	L	L	L	L						N	N	N	N	E																											
	0.15µF (154)										N	N	N	N																												
	0.22µF (224)	L	L	L							N	N	N	N	N																											
	0.27µF (274)																																									
	0.33µF (334)	L	L								N	N																														
	0.39µF (394)																																									
	0.47µF (474)	L									N	N	E	E	E																											
	0.68µF (684)										N	N																														
0.82µF (824)																																										
1.0µF (105)	L	L	L							N	N	N	N																													
1.5µF (155)																																										
2.2µF (225)	L	L								N	N	E	E																													
3.3µF (335)																																										
4.7µF (475)										E	E	E																														
6.8µF (685)																																										
10µF (106)										E	E																															
22µF (226)																																										
47µF (476)																																										
100µF (107)																																										
220µF (227)																																										

1. The letter in cell is expressed the symbol of product thickness.



## Middle & High Voltage Capacitors 200V~4000V

### ■ FEATURES

- \* High voltage in a given case size.
- \* High stability and reliability.

### ■ GENERAL ELECTRICAL DATA

Dielectric	NP0	X7R	Y5V
Size	0603, 0805, 1206, 1210, 1808, 1812, 1825, 2220, 2225		0805, 1206, 1210, 1812
Capacitance	0.5pF to 0.12μF		100pF to 2.2μF
Capacitance tolerance	Cap≤5pF: C (±0.25pF) 5pF<Cap<10pF: D (±0.5pF) Cap≥10pF: J (±5%), K (±10%)		0.01μF to 0.68μF
Rated voltage (WVDC)	200V to 4000V		Z (-20/+80%)
DF/ Q	Cap<30pF: Q≥400+20C Cap≥30pF: Q≥1000		≤2.5%
Insulation resistance at Ur	Ur=200~630V: ≥10GΩ or RxC≥100Ω·F whichever is smaller Ur=1000~3000V: ≥10GΩ		
Dielectric strength	200~300V: ≥2 x WVDC 400V~450V: ≥1.2 x WVDC 500~999V: ≥1.5 x WVDC 1000~3000V: ≥1.2 x WVDC 4000: ≥1.1 x WVDC		
Operating temperature	-55 to +125°C		200V, 250V
Capacitance characteristic	±30ppm		±15%
Termination	+30/-80%		
	Ni/Sn (lead-free termination)		

### ■ CAPACITANCE RANGE

#### Y5V Dielectric 200V to 250V

DIELECTRIC		Y5V							
SIZE		0805		1206		1210		1812	
RATED VOLTAGE (VDC)		200	250	200	250	200	250	200	250
Capacitance	0.010μF (103)	B	B	B	B	C	C	D	D
	0.015μF (153)	B	B	B	B	C	C	D	D
	0.022μF (223)	B	B	B	B	C	C	D	D
	0.033μF (333)	B	B	B	B	C	C	D	D
	0.047μF (473)	B	B	B	B	C	C	D	D
	0.068μF (683)	B	B	B	B	C	C	D	D
	0.10μF (104)			B	B	C	C	D	D
	0.15μF (154)			C	C	C	C	D	D
	0.22μF (224)							D	D
	0.33μF (334)							D	D
0.47μF (474)							D	D	
0.68μF (684)							D	D	

1. The letter in cell is expressed the symbol of product thickness.







## General Information

### ■ Constructions

No.	Name	NP0	NPO/X7R/X5R/Y5V
①	Ceramic material	BaTiO <sub>3</sub> based	
②	Inner electrode	AgPd alloy	Ni
③	Termination	Inner layer	Ag
④		Middle layer	Ni
⑤		Outer layer	Sn

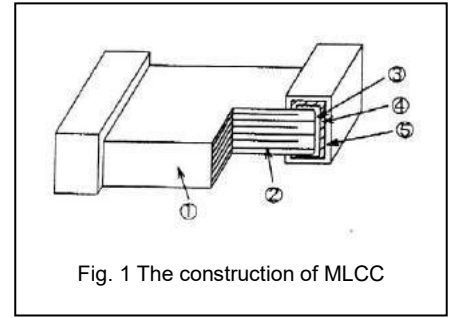

Fig. 1 The construction of MLCC

### ■ Storage and handling conditions

- To store products at 5 to 40°C ambient temperature and 20 to 70% related humidity conditions.
- The product is recommended to be used within one year after shipment. Check solderability in case of shelf life extension is needed.

### Cautions:

- The corrosive gas reacts on the terminal electrodes of capacitors, and results in the poor solderability. Do not store the capacitors in the ambience of corrosive gas (e.g., hydrogen sulfide, sulfur dioxide, chlorine, ammonia gas etc.)
- In corrosive atmosphere, solderability might be degraded, and silver migration might occur to cause low reliability.
- Due to the dewing by rapid humidity change, or the photochemical change of the terminal electrode by direct sunlight, the solderability and electrical performance may deteriorate. Do not store capacitors under direct sunlight or dewing condition. To store products on the shelf and avoid exposure to moisture.

### ■ Recommended soldering conditions

The lead-free termination MLCCs are not only to be used on SMT against lead-free solder paste, but also suitable against lead-containing solder paste. If the optimized solder joint is requested, increasing soldering time, temperature and concentration of N<sub>2</sub> within oven are recommended.

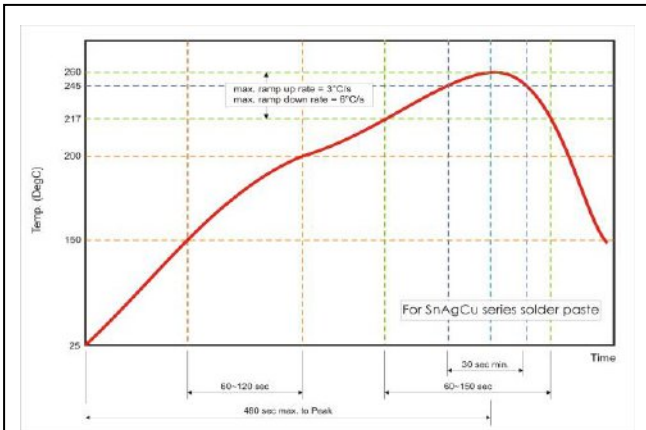

Fig. 2 Recommended reflow soldering profile for SMT process with SnAgCu series solder paste.

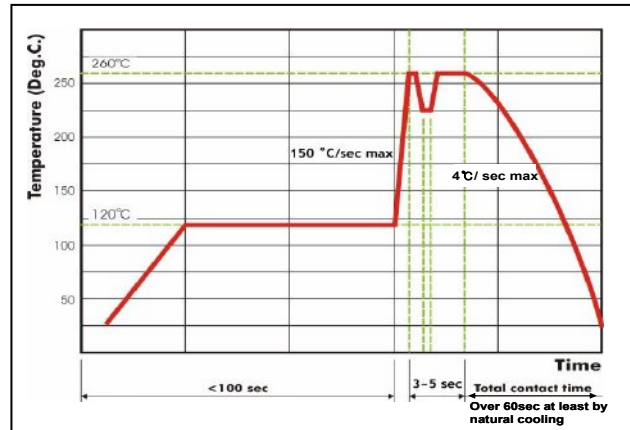

Fig. 3 Recommended wave soldering profile for SMT process with SnAgCu series solder.