

50W isolated DC-DC converter with ultra-wide, ultra-high 80 (120) -750VDC input for Renewable Energy



RoHS



## FEATURES

- Ultra-wide input voltage range of 120 - 750VDC (PV50-25B12) / 80 - 750VDC (PV50-25B24)
- Industrial grade operating temperature -40°C to +70°C
- High I/O isolation test voltage of 4000VAC
- High efficiency, low ripple & noise
- High reliability, long lifespan
- Input under-voltage protection, input reverse polarity protection, output short circuit, over-current, over-voltage protection
- Operating up to 5000m altitude

PV50-25Bxx Series is a regulated DC-DC converter with an ultra-wide and ultra-high DC input of 80 (120-) - 750VDC, which design based on standard of UL1741, EN62109. The products feature high efficiency, high reliability, high insulation and a high level of safety protection. It is widely used in renewable energy industries such as photovoltaic inverter, household energy storage. The converters provide multiple protection features and guarantee stable and safe operating environments even under abnormal working conditions. For extremely harsh EMC environment, we recommend using the application circuit show in Design Reference of this datasheet.

## Selection Guide

Certification	Part No.	Output Power	Nominal Output Voltage and Current (Vo/Io)	Efficiency at 300VDC(%) Typ.	Capacitive Load (µF) Max.
EN	PV50-25B12	50W	12V/4170mA	83	820
	PV50-25B24	50W	24V/2083mA	85	820

## Input Specifications

Item	Operating Conditions	Min.	Typ.	Max.	Unit	
Input Voltage Range	PV50-25B12	120	--	750	VDC	
	PV50-25B24	80	--	750		
Input Current	150VDC	--	--	0.9	A	
	750VDC	--	--	0.3		
Inrush Current	750VDC	PV50-25B12	--	60		--
		PV50-25B24	--	80		--
Input Under-voltage Protection	Lockout activation range	60	--	70	VDC	
	Lockout deactivation range	70	--	80		
External Input Fuse		3.15A/1000VDC, required				
Hot Plug		Unavailable				

## Output Specifications

Item	Operating Conditions	Min.	Typ.	Max.	Unit	
Output Voltage Accuracy	All load range	--	±2	--	%	
Line Regulation	Rated load	--	±1	--		
Load Regulation	0% - 100% load	--	±2	--		
Ripple & Noise*	20MHz bandwidth (peak-to-peak value)	--	--	200	mV	
Stand-by Power Consumption	500VDC	--	--	1.2	W	
Temperature Coefficient		--	±0.02	--	%/°C	
Short Circuit Protection		Hiccup, continuous, self-recovery				
Over-current Protection		≥ 110%Io, hiccup, self-recovery				
Over-voltage Protection	PV50-25B12	≤ 16VDC	Output voltage clamp			
	PV50-25B24	≤ 30VDC				
Minimum Load		0	--	--	%	
Hold-up Time	Room temperature, full load	750VDC input	--	10	--	ms
Start-up Delay Time	Room temperature		--	--	3	s

Note: \* The "Tip and barrel method" is used for ripple and noise test, please refer to PV Converter Application Notes for specific information.

General Specifications

Item	Operating Conditions		Min.	Typ.	Max.	Unit
Isolation	Input - output	Electric Strength Test for 1min., leakage current <10mA	4000	--	--	VAC
Insulation Resistance	Input - output	500VDC	≥50x10 <sup>6</sup>			Ω
Operating Temperature			-40	--	+70	°C
Storage Temperature			-40	--	+85	
Storage Humidity			--	--	95	%RH
Switching Frequency			--	65	--	kHz
Power Derating	-40°C to -25°C	PV50-25B12	3.33	--	--	% / °C
	-40°C to -25°C	PV50-25B24	2.66	--	--	
	+50°C to +70°C	PV50-25B12	2.5	--	--	
	+55°C to +70°C	PV50-25B24	2.66	--	--	
	120VDC - 150VDC	PV50-25B12	0.667	--	--	% / VDC
	80VDC - 150VDC	PV50-25B24	0.714	--	--	
	650VDC - 750VDC		0.2	--	--	
	2000m - 5000m	PV50-25B12	10	--	--	% / Km
Switching Frequency			--	65	--	kHz
Safety Standard			EN62109-1; Design refer to UL1741			
MTBF			MIL-HDBK-217F@25°C ≥ 300,000 h			

Mechanical Specifications

Case Material	Black flame-retardant and heat-resistant plastic (UL94V-0)
Dimensions	109.00 x 58.50 x 30.00mm
Weight	260 g (Typ.)
Cooling method	Free air convection

Electromagnetic Compatibility (EMC)

Emissions	CE	CISPR32/EN55032	CLASS A	
	RE	CISPR32/EN55032	CLASS A	
Immunity	ESD	IEC/EN61000-4-2	Contact ±6KV/Air ±8KV	Perf. Criteria B
	RS	IEC/EN61000-4-3	10V/m	Perf. Criteria A
	EFT	IEC/EN61000-4-4	±2KV	Perf. Criteria B
	Surge	IEC/EN61000-4-5	line to line ±1KV/ line to line ±2KV (See Fig. 2 for recommended circuit)	Perf. Criteria B
	CS	IEC/EN61000-4-6	10Vr.m.s	Perf. Criteria A

Product Characteristic Curve

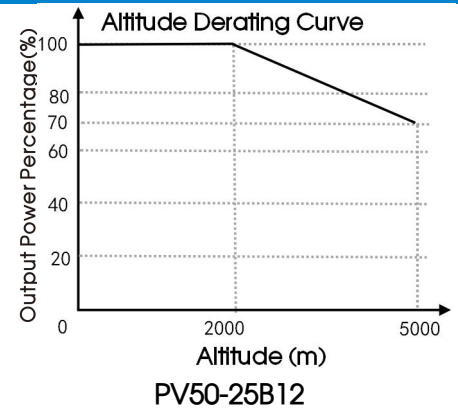
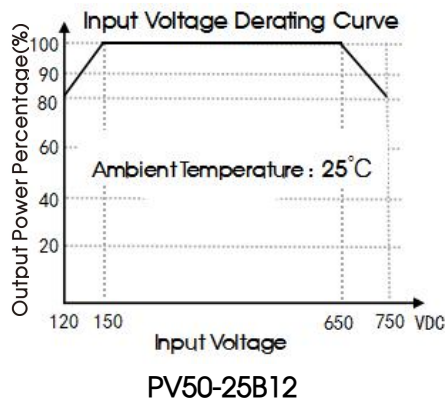
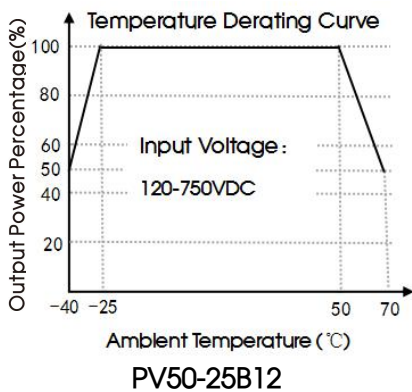

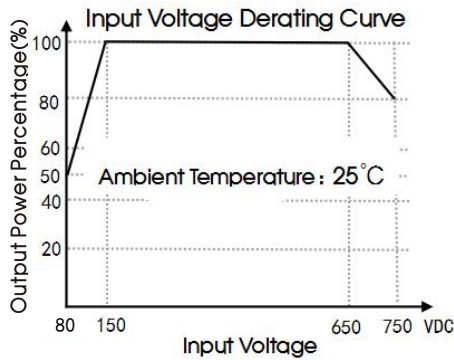

PV50-25B24

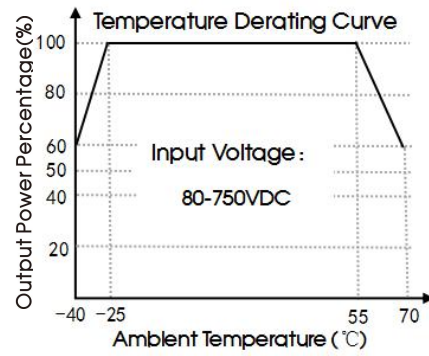

PV50-2B24

Note: ① With an input between 80-150VDC/120-150VDC/650-750VDC, the output power of PV50-25Bxx parts must be derated as per temperature derating curves;

② This product is suitable for use in natural air cooling environments, if in a closed environment, please contact our company's FAE.

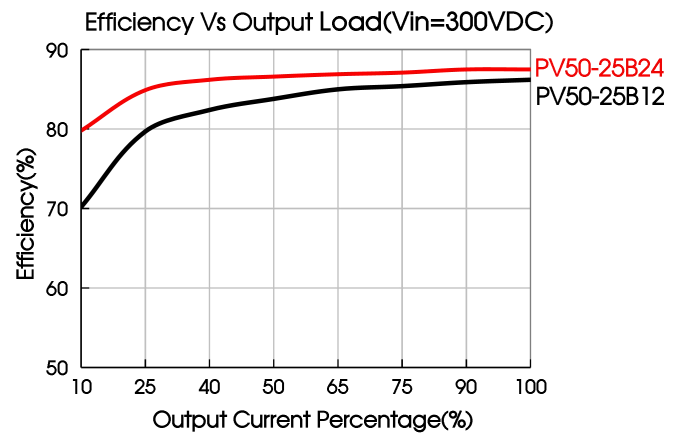
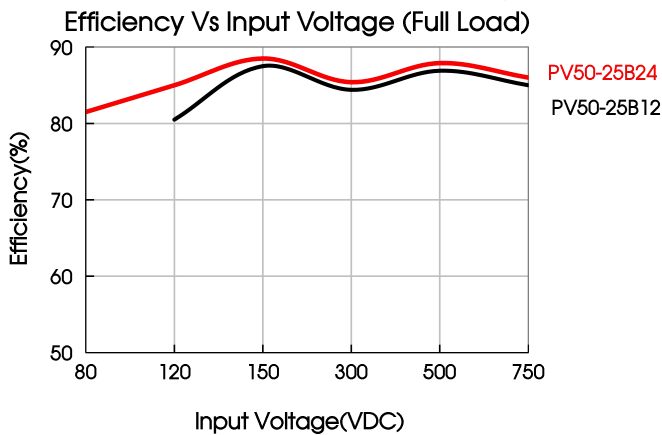

## Design Reference

### 1. Typical application circuit

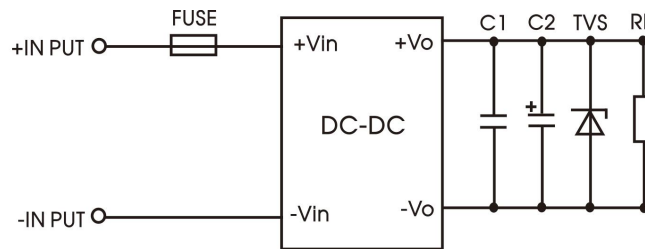

Fig. 1

Model	FUSE	C1	C2	TVS
PV50-25B12	3.15A/1000VDC, required	1uF/25V	10uF/25V	SMBJ20A
PV50-25B24	3.15A/1000VDC, required	1uF/50V	10uF/35V	SMBJ30A

Note on filter components:

We recommend using an electrolytic capacitor with high frequency and low ESR rating for C2 (refer to manufacture's datasheet). Choose a capacitor voltage rating with at least 20% margin, in other words not exceeding 80%. C1 is a ceramic capacitor, used to filter high-frequency noise. TVS is a recommended suppressor diode to protect the application in case of a converter failure.

2. EMC compliance recommended circuit

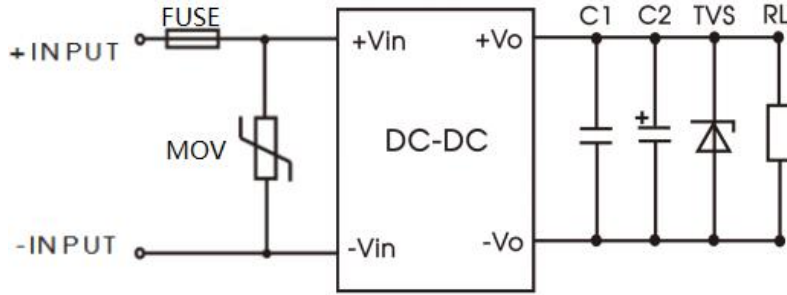

Fig. 2

Model	FUSE	C1	C2	TVS	MOV
PV50-25B12	3.15A/1000VDC, required	1uF/25V	10uF/25V	SMBJ20A	S10K625
PV50-25B24	3.15A/1000VDC, required	1uF/50V	10uF/35V	SMBJ30A	S10K625

3. For additional information please refer to application notes on [www.mornsun-power.com](http://www.mornsun-power.com).

Dimensions and Recommended Layout (PV50-25B12)

THIRD ANGLE PROJECTION

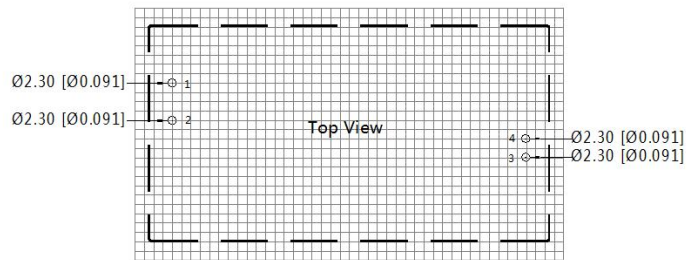
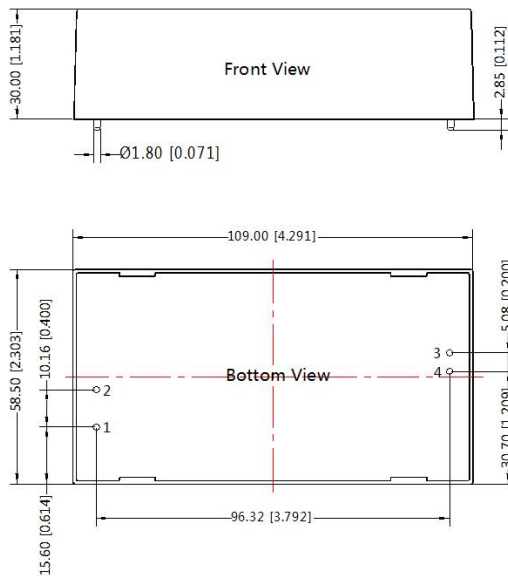

Note: Grid 2.54\*2.54mm

Pin-Out	
Pin	Mark
1	-Vin
2	+Vin
3	-Vo
4	+Vo

Note:  
Unit: mm[inch]  
Pin1,2,3,4's diameter: 1.80[0.071]  
Pin diameter tolerances: ±0.10[±0.004]  
Pin tolerances(H): ±0.250[±0.010]  
General tolerances: ±0.50[±0.020]

Dimensions and Recommended Layout (PV50-25B24)

THIRD ANGLE PROJECTION 

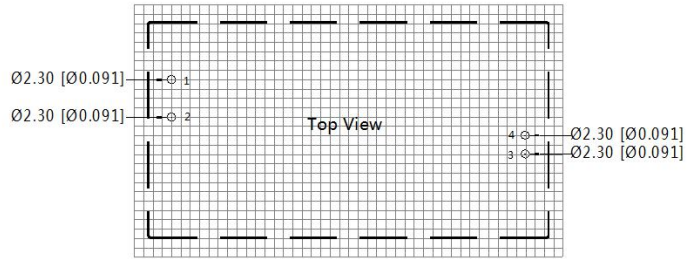
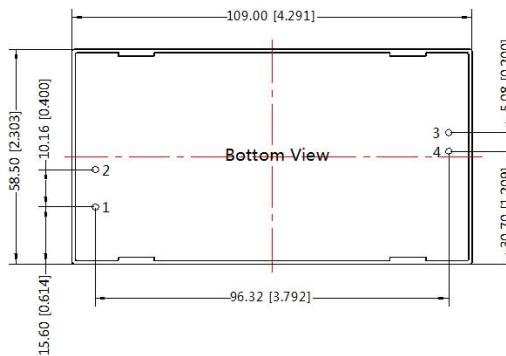
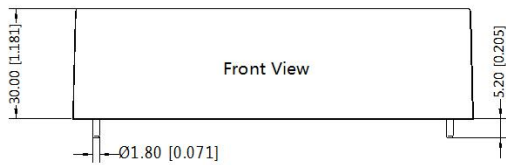

Note: Grid 2.54\*2.54mm

Pin-Out	
Pin	Mark
1	-Vin
2	+Vin
3	-Vo
4	+Vo

Note:  
Unit: mm[inch]  
Pin1,2,3,4's diameter: 1.80[0.071]  
Pin diameter tolerances:  $\pm 0.10[\pm 0.004]$   
Pin tolerances(H):  $\pm 0.50[\pm 0.020]$   
General tolerances:  $\pm 0.50[\pm 0.020]$

- Note:
1. For additional information on Product Packaging please refer to [www.mornsun-power.com](http://www.mornsun-power.com). Packaging bag number: 58220020;
  2. Unless otherwise specified, parameters in this datasheet were measured under the conditions of  $T_a=25^\circ\text{C}$ , humidity<75% with nominal input voltage and rated output load;
  3. All index testing methods in this datasheet are based on our company corporate standards;
  4. We can provide product customization service, please contact our technicians directly for specific information;
  5. Products are related to laws and regulations: see "Features" and "EMC";
  6. Our products shall be classified according to ISO14001 and related environmental laws and regulations, and shall be handled by qualified units.

Mornsun Guangzhou Science & Technology Co., Ltd.

Address: No. 5, Kehui St. 1, Kehui Development Center, Science Ave., Guangzhou Science City, Huangpu District, Guangzhou, P. R. China  
Tel: 86-20-38601850 Fax: 86-20-38601272 E-mail: [info@mornsun.cn](mailto:info@mornsun.cn) [www.mornsun-power.com](http://www.mornsun-power.com)