

50W, specific power supply for power grid



FEATURES

- Specific power supply designing for smart grid
- Ultra-wide 85 - 305VAC and 88 - 430VDC input voltage range
- Ultra-wide operating ambient temperature range: -40°C to +85°C
- High reliability, low output ripple & noise
- Immunity meets electricity standard Level 4
- Meets impulse voltage requirements of 1.2/50us 5KV
- Designed to meet UL/EN/IEC62368 standards
- EN62368 safety approval

LO50-23BxxE series is a special power supply design for the smart grid industry that meets the power industry standards. It features AC input and at the same time accepts DC input voltage, with ultra-wide input voltage range, wide operating temperature range, high reliability, and high isolation. EMC and safety specifications meet IEC/EN61000-4, CISPR32/EN55032, UL/EN/IEC62368 standards. It is suitable for smart grid occasions with poor power quality and high reliability requirements, such as smart power transmission and substations. It also can be used in microcomputer protection equipment, bus voltage protection equipment or equipment with high reliability requirements that require 110VDC input voltage.

Selection Guide

Certification	Part No.	Output Power	Nominal Output Voltage and Current (Vo/Io)	Output Voltage Adjustable Range(V)	Efficiency at 230VAC (%) Typ.	Capacitive Load (μF) Max.
CE	LO50-23B03E	33W	3.3V/10A	2.97-3.63	84	20000
	LO50-23B05E	50W	5V/10A	4.5-5.5	86	20000
	LO50-23B09E	50.4W	9V/5.6A	8.1-9.9	86	10000
	LO50-23B12E	50.4W	12V/4.2A	10.8-13.2	86	8000
	LO50-23B15E	51W	15V/3.4A	13.5-16.5	86	4000
	LO50-23B24E	50.4W	24V/2.1A	21.6-26.4	87	2000
	LO50-23B27E	51.3W	27V/1.9A	24.3-29.7	88	2000
	LO50-23B48E	52.8W	48V/1.1A	43.2-52.8	89	1000

Input Specifications

Item	Operating Conditions	Min.	Typ.	Max.	Unit
Input Voltage Range	AC input	85	--	305	VAC
	DC input	88	--	430	VDC
Input Frequency		47	--	63	Hz
Input Current	115VAC	--	--	1.2	A
	230VAC	--	--	0.8	
Inrush Current	115VAC	--	20	--	A
	230VAC	--	40	--	
Leakage Current	277VAC	0.5mA RMS max.			
Hot Plug		Unavailable			

Output Specifications

Item	Operating Conditions	Min.	Typ.	Max.	Unit
Output Voltage Accuracy	0% - 100% load	--	±2	--	%
Line Regulation	Rated load	--	±0.5	--	
Load Regulation	230VAC	--	±1	--	
Ripple & Noise*	100MHz bandwidth (peak-to-peak value)	--	--	150	mV
Stand-by Power Consumption		--	--	0.5	W
Short Circuit Protection		Hiccup, continuous, self-recovery			
Over-current Protection		≥110%Io, self-recovery			

Over-voltage Protection	3.3VDC output	≤5.5V (Output voltage clamp, hiccup)			
	5VDC output	≤7.5V (Output voltage clamp, hiccup)			
	9VDC output	≤13.5V (Output voltage clamp, hiccup)			
	12VDC output	≤16V (Output voltage clamp, hiccup)			
	15VDC output	≤21V (Output voltage clamp, hiccup)			
	24VDC output	≤32V (Output voltage clamp, hiccup)			
	27VDC output	≤35V (Output voltage clamp, hiccup)			
	48VDC output	≤60V (Output voltage clamp, hiccup)			
Minimum Load		0	--	--	%
Start-up Delay Time		--	--	500	ms
Hold-up Time	115VAC input, Io=100%	--	28	--	ms
	230VAC input, Io=100%	--	150	--	

Note: *The "Tip and barrel method" is used for ripple and noise test, with a 0.1uf ceramic capacitor & 100uf parallel capacitor, please refer to AC-DC Converter Application Notes for specific information.

General Specifications

Item		Operating Conditions	Min.	Typ.	Max.	Unit
Isolation	Input-output	Electric Strength Test for 1min., leakage current <10mA	4000	--	--	VAC
	Input-PE	Electric Strength Test for 1min., leakage current <10mA	2000	--	--	VAC
	Output-PE	Electric Strength Test for 1min., leakage current <20mA	500	--	--	VAC
Insulation Resistance	Input-output	500VDC	≥50x10 ⁶			Ω
	Input-PE					
	Output-PE					
Operating Temperature			-40	--	+85	°C
Storage Temperature			-40	--	+105	
Altitude			--	--	5000	m
Switching Frequency			--	65	--	kHz
Power Derating	Natural air cooling	-40°C to -25°C	3.33	--	--	% / °C
		+50°C to +70°C	2.5	--	--	
		+70°C to +85°C	0.66	--	--	
	Forced cooling wind speed ≥ 0.7m/s	+60°C to +70°C	3	--	--	% / VAC
		+70°C to +85°C	1.33	--	--	
		85VAC - 100VAC	1.33	--	--	% / Km
		277VAC - 305VAC	0.72	--	--	
	2000m-5000m	5	--	--		
Safety Standard			UL62368/EN62368/IEC62368			
Safety Certification			EN62368			
Safety Class			CLASS I			
MTBF			MIL-HDBK-217F@25°C > 300,000 h			
Designed life	230VAC	+25°C	≥130 x 10 ³ h			
		+50°C	≥70 x 10 ³ h			
		+70°C	≥44 x 10 ³ h			
		+85°C	>29 x 10 ³ h			

Mechanical Specifications

Dimension	132.00 x 50.00 x 27.10 mm
Weight	145g (Typ.)
Cooling method	Free air convection

Electromagnetic Compatibility (EMC)

Emissions	CE	CISPR32/EN55032	CLASS B	
	RE	CISPR32/EN55032	CLASS A	
Immunity	ESD	IEC/EN61000-4-2	Contact ±8KV/ Air ±15KV	Perf. Criteria B
	RS	IEC/EN61000-4-3	10V/m	perf. Criteria A
	EFT	IEC/EN61000-4-4	±4KV	perf. Criteria B
	Surge	IEC/EN61000-4-5	Line to line±2KV/ line to ground±4KV	perf. Criteria B
	CS	IEC/EN61000-4-6	10 Vr.m.s	perf. Criteria A
	Voltage dips, short interruption and voltage variations	IEC/EN61000-4-11	0%, 70%	perf. Criteria B

Product Characteristic Curve

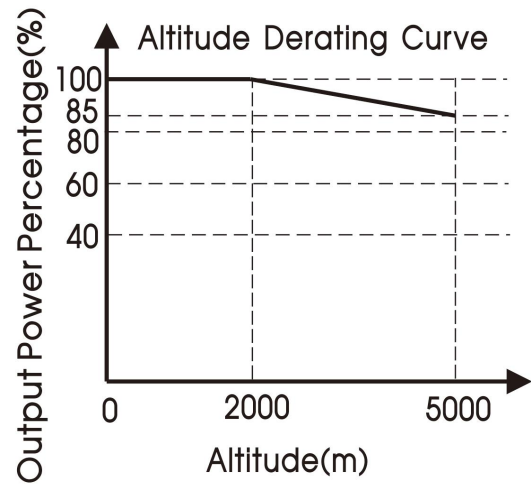
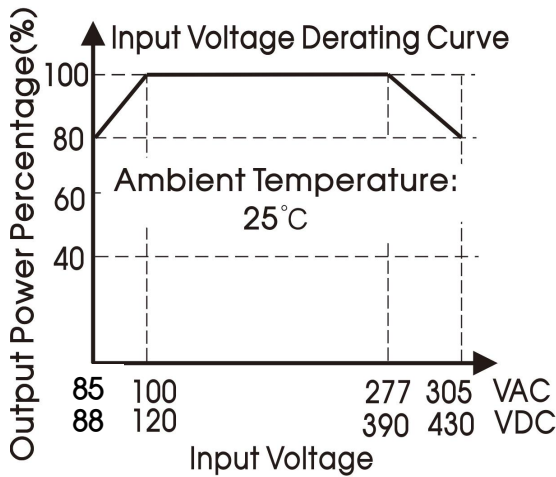
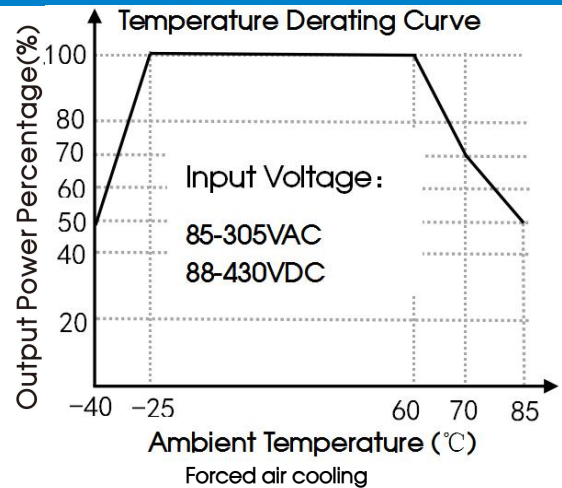
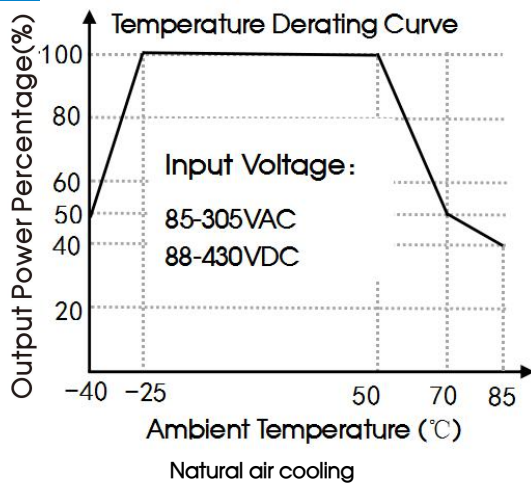

Note: ① With an AC input between 85-100VAC/277-305VAC and a DC input between 88-120VDC/390-430VDC, the output power must be derated as per temperature derating curves;

② This product is suitable for applications using natural air cooling; for applications in closed environment please consult factory or one of our FAE.

Efficiency Vs Input Voltage (Full Load)

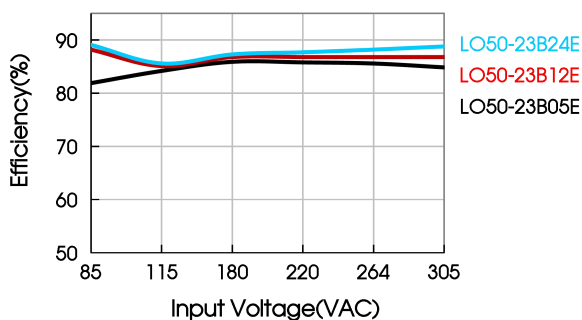

Efficiency Vs Output Load (Vin=230VAC)

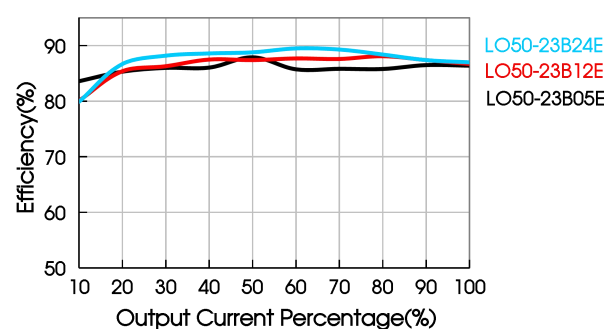

Design Reference

1. Typical application

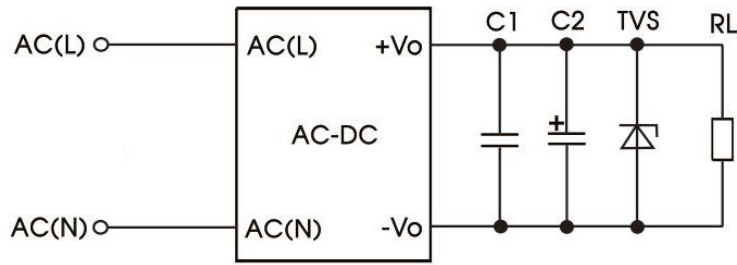

Fig. 1: Typical circuit diagram

Part no.	C1	C2	TVS
LO50-23B03E	0.1μF/250V	100μF/63V	SMBJ7.0A
LO50-23B05E			SMBJ7.0A
LO50-23B09E			SMBJ12A
LO50-23B12E			SMBJ20A
LO50-23B15E			SMBJ20A
LO50-23B24E			SMBJ30A
LO50-23B27E			SMBJ30A
LO50-23B48E			SMBJ64A

Output Filter Components:

We recommend using an electrolytic capacitor with high frequency, and low ESR rating for C2 (refer to manufacture's datasheet). Choose a capacitor voltage rating with at least 20% margin, in other words not exceeding 80%. C1 is a ceramic capacitor used for filtering high-frequency noise and TVS is a recommended suppressor diode to protect the application in case of a converter failure.

2. For additional information please refer to application notes on www.mornsun-power.com.

Dimensions and Recommended Layout

THIRD ANGLE PROJECTION

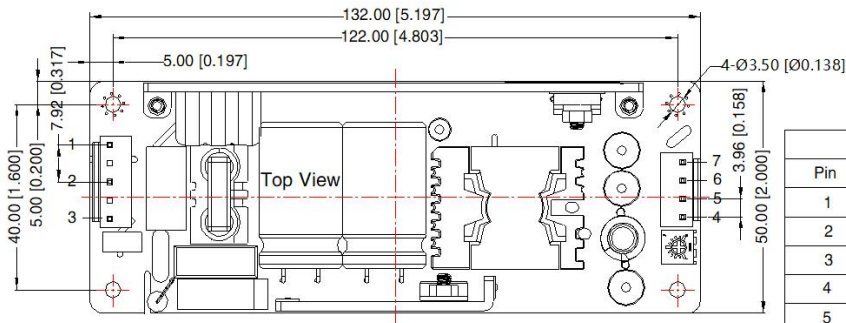

Pin-Out			
Pin	Mark	Connector	Terminal
1	PE	JST B5P-VH or equivalent	Housing: JST VHR Contact: JST SVH-21T-P1.1 or equivalent
2	AC(N)		
3	AC(L)		
4	+Vo	JST B4P-VH or equivalent	
5	-Vo		
6			
7			

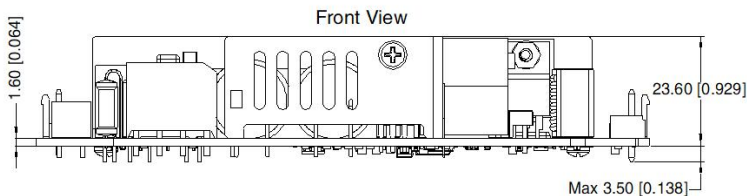

Note:
Unit: mm[inch]
General tolerances: ± 1.00[± 0.039]
The layout of the device is for reference only, please refer to the actual product

Note:

1. For additional information on Product Packaging please refer to www.mornsun-power.com. Packaging bag number: 58220179;
2. Unless otherwise specified, parameters in this datasheet were measured under the conditions of $T_a=25^{\circ}\text{C}$, humidity<75% with nominal input voltage and rated output load;
3. All index testing methods in this datasheet are based on our company corporate standards;
4. We can provide product customization service, please contact our technicians directly for specific information;
5. Products are related to laws and regulations: see "Features" and "EMC";
6. Our products shall be classified according to ISO14001 and related environmental laws and regulations, and shall be handled by qualified units.

Mornsun Guangzhou Science & Technology Co., Ltd.

Address: No. 5, Kehui St. 1, Kehui Development Center, Science Ave., Guangzhou Science City, Huangpu District, Guangzhou, P. R. China

Tel: 86-20-38601850

Fax: 86-20-38601272

E-mail: info@mornsun.cn

www.mornsun-power.com