

Product Specification

Product Class: LED LENS

Item No: DK-173-60x60-36H1

Material: PC (UV)

Certification: RoHS

Set up: Xuan Yang

Check: Xiaohui Liang

Content

Specification-----	3
2D Drawing-----	4
Optical Datasheet-----	5
Packing-----	6
Application Notes-----	7

Specification

Item No	Picture	Size	Matched LED	Lighting Application
DK-173-60x60-36H1		Diameter: 173*71.4mm Height:9.23mm FWHM:60*60°	3030	Streetlight

Drawing

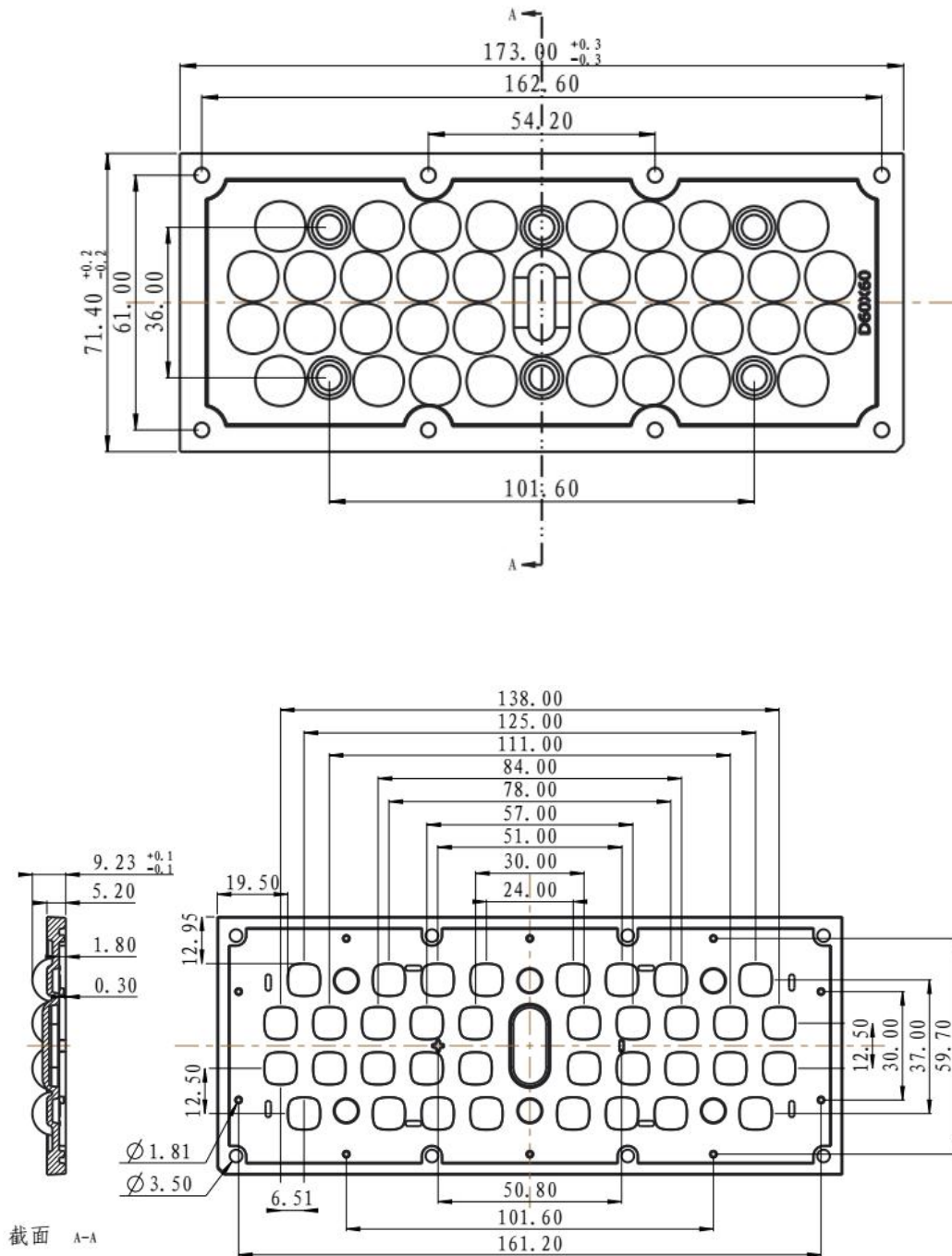

Optical Test Report

产品特征

灯具制造厂商:
电压: 34.0 V
功率: 11.12 W

电流: 0.327 A
功率因数: 1.000

光度结果

灯具CIE分类: 直接型
灯具光通量: 1309.1 lm
下射光通量比: 96%
水平扩散角 (10%, 50%, 75%, 100%): H77.6, H60.9, H51.9, H3
垂直扩散角 (10%, 50%, 75%, 100%): V77.6, V60.6, V49.7, V8
灯具光效等级 (LER): 117.77
峰值光强: 1366.96 cd
S/MH(C0/C180): 1.01

额定光通量: 1309.1 lm
灯具效率: 100%
上射光通量比: 4%
中心光强: 1316.08 cd
峰值光强位置: H270 V8
S/MH(C90/C270): 1.02

灯具实物照片

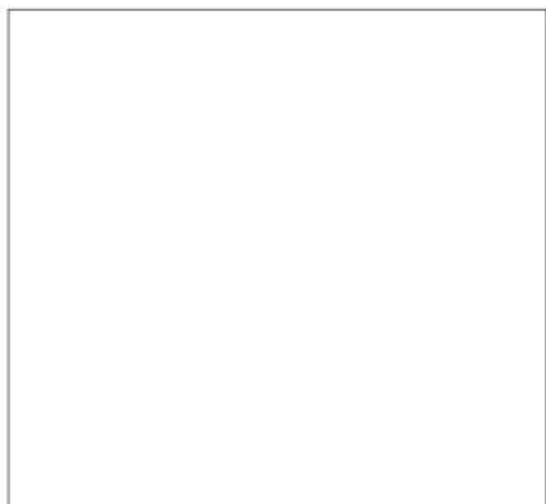

配光曲线

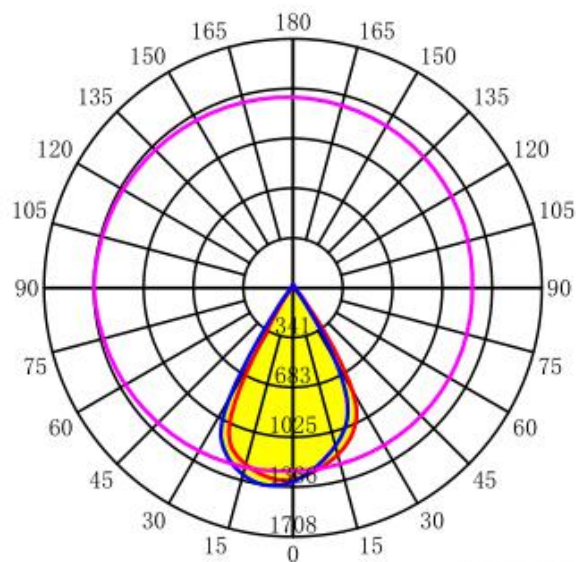

单位: cd

平均光束角 (50%): 60.6°

— C0-C180 — C90-C270 — G8

配光曲线

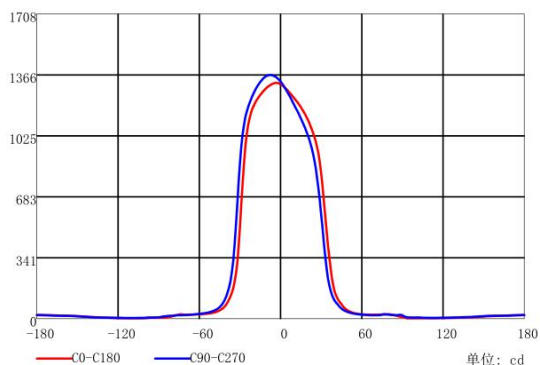
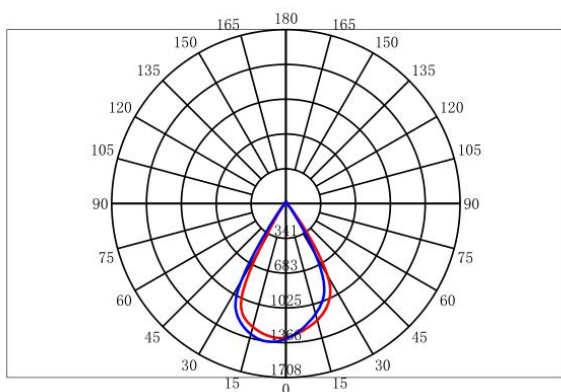

单位: cd

Packing

Material	Size	Packing Instruction
EPE	315*230mm	87PCS/1 Box 4 Box/1 Carton
Plastic bag	170*190mm	
White Paperboard	A level; 400g; 310*235mm	
Box	335*245*105mm	
Carton	A=B 510*330*255mm	

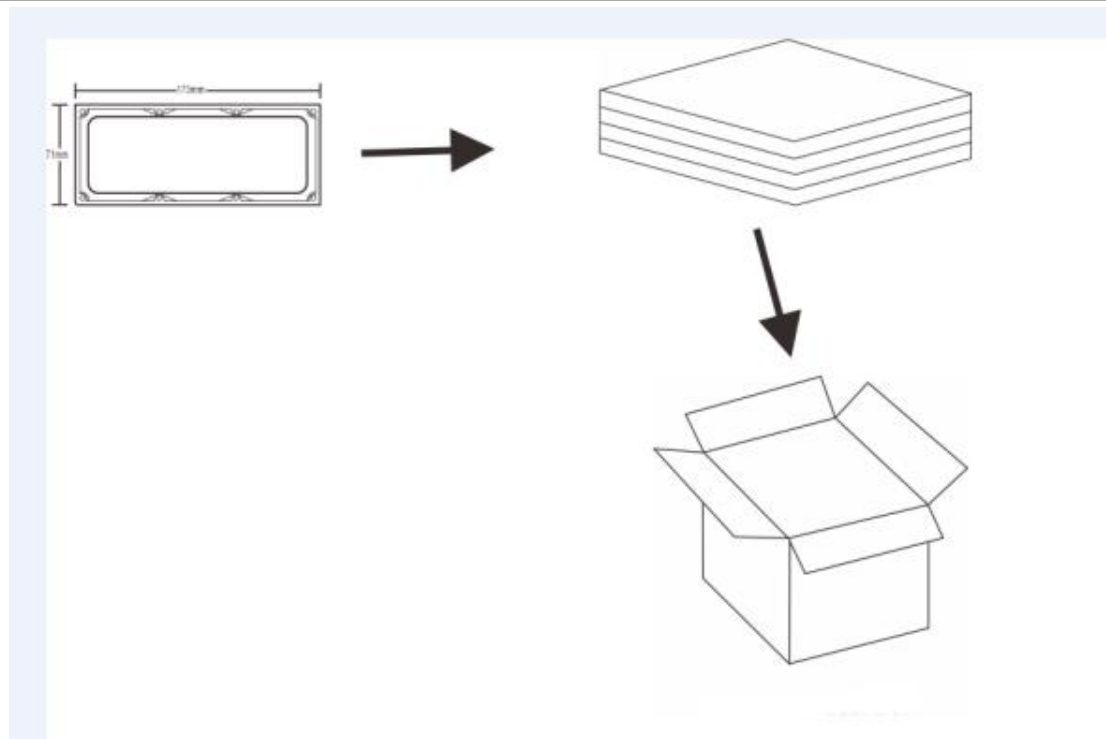

Application Notes

(1) Please use a little water and soft fabric (air-laid paper) to clean the product if necessary.

(2) Forbid to use industrial solvent to clean the product, such as alcohol.

(3) The working temperature is $-40^{\circ}\text{C}\sim+80^{\circ}\text{C}$ (PMMA) or $-35^{\circ}\text{C}\sim+120^{\circ}\text{C}$ (PC).

(4) Storage environment temperature is $0^{\circ}\text{C}\sim40^{\circ}\text{C}$, humidity is 30%~95%.

(5) The product has the function to change the ray of light, it is made of optical material, the effect shall be influenced once pollute. Please do not open the packing before use it, to avoid the dust pollution.

(6) Protect the product from the sun and other ultraviolet ray, as these will lead to aging, change color, crack, etc.

(7) Please wear gloves once install the product, avoid to abrasion the product surface.

(8) Forbid to use acidic or alkaline solution touch the product, avoid to generate the chemical reactions.