

# LTE+WIFI Combination Antenna JCG305LW

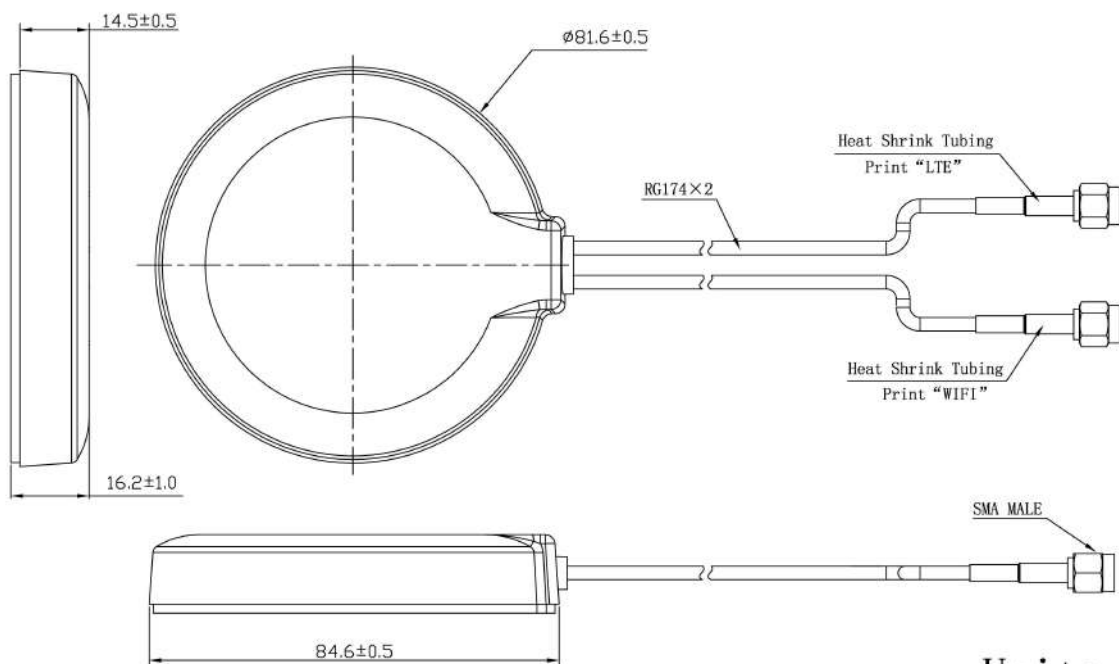

## DIMENSIONS



Unit: mm



## SPECIFICATIONS

Item	Specifications	
LTE Antenna	Frequency Range	698~960MHz/1710~2700MHz
	V.S.W.R	<3.0
	Polarization	Linear
	Gain	2.0dBi
	Impedance	50Ω
WIFI Antenna	Frequency Range	2400~2483.5MHz/4900~5825MHz
	Polarization	Linear
	Gain	3dBi
	V.S.W.R	<2.0
	Impedance	50Ω
Mechanical	Cable	RG174
	Connector	SMA/FAKRA or others
	Material	ABS
	Mounting Method	Adhesive/Magnet
Environmental	Operating Temperature	-40℃~+85℃
	Relative Humidity	Up to 95%
	Ingress Protection	IP67
	Vibration	10 to 55Hz with 1.5mm amplitude 2hours
	Environmentally Friendly	ROHS Compliant

## Radiation Pattern

LTE Antenna

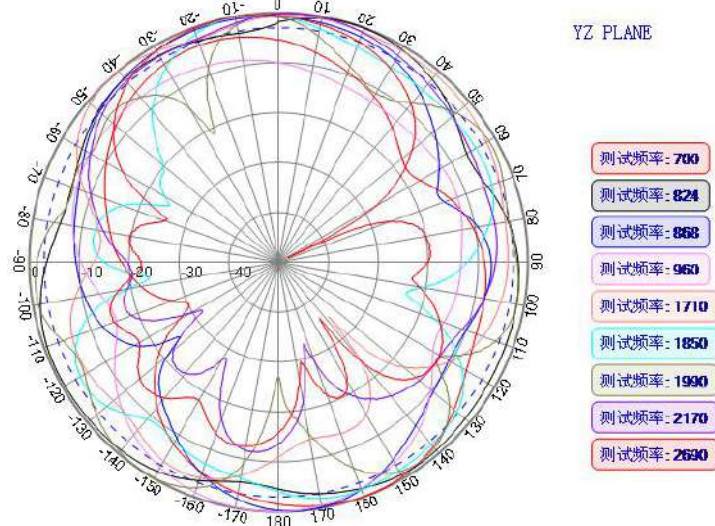
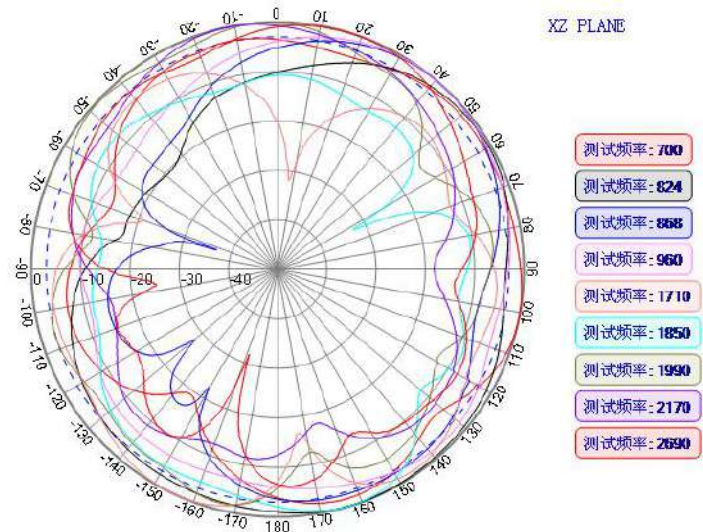
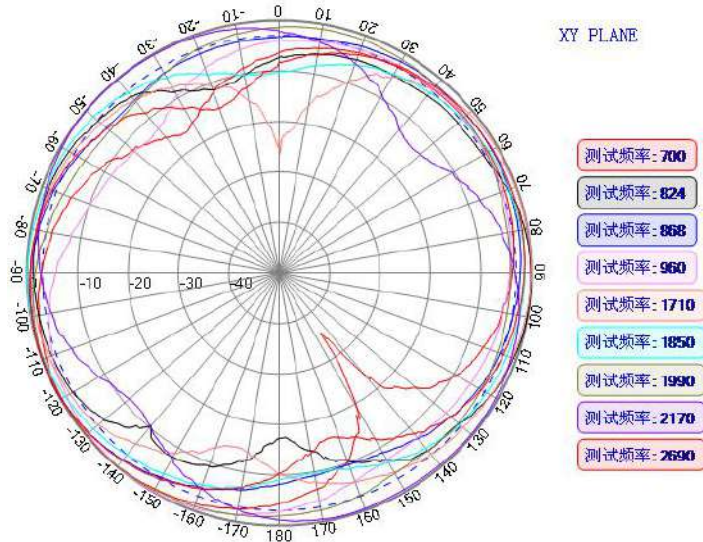

## WIFI Antenna

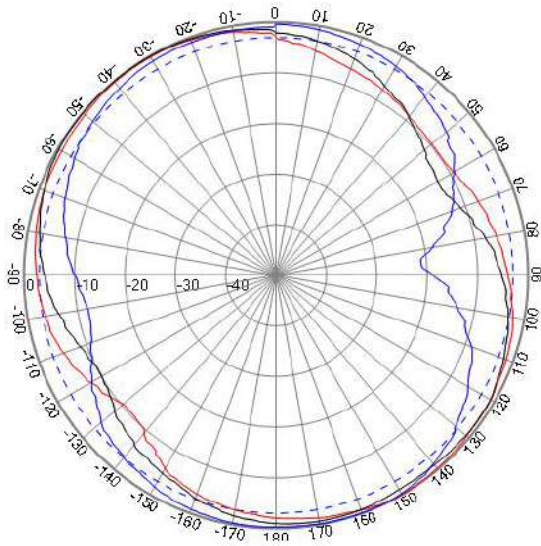

XY PLANE

测试频率: 2400

测试频率: 2450

测试频率: 2483

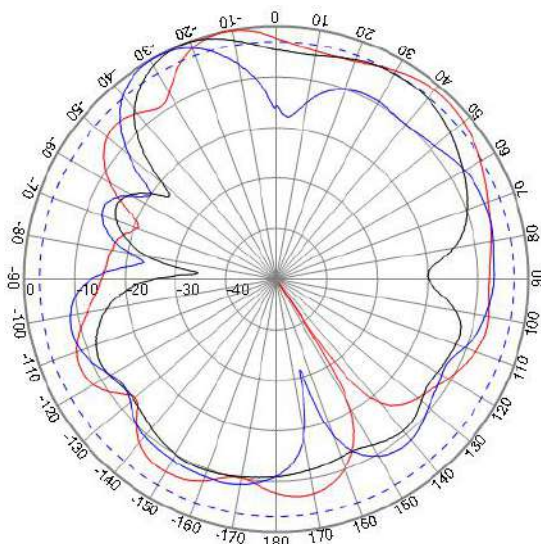

YZ PLANE

测试频率: 2400

测试频率: 2450

测试频率: 2483

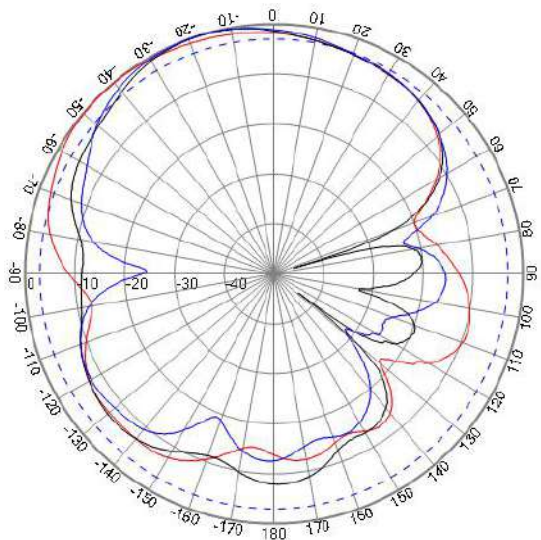

XZ PLANE

测试频率: 2400

测试频率: 2450

测试频率: 2483