

ODU MINI-SNAP[®] SERIES L RIGHT-ANGLED PLUG FOR CABLE BEND RELIEF, SIZE 1, IP50, 8 CONTACTS, 0° KEY



- **Part number** W21L0C-PD8MCD0-770S
- **Type of connector** Right-angled plug for cable bend relief
- **Size** 1
- **Number of contacts** 8
- **Keying** 0°
- **Cable diameter** 7 - 7.7 mm



DIMENSIONS:

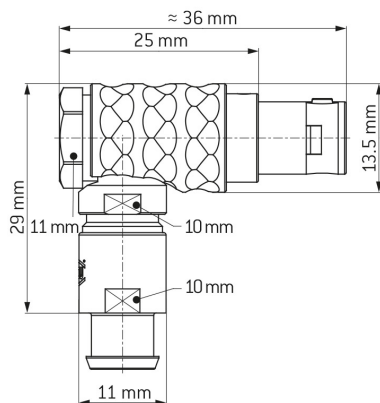

POSITIONS: 8 positions

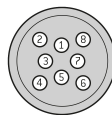

CODING: 0°



Contact Insert Description

| | |
|---------------------------|---------|
| Number of contacts | 8 |
| Contact type | Pins |
| Contact diameter | 0.5 mm |
| Insulator material | PEEK |
| Wire cross section | 26 AWG |
| Termination type | Solder |
| Termination diameter | 0.65 mm |
| Reverse gender on request | |

ODU MINI-SNAP[®] SERIES L RIGHT-ANGLED PLUG FOR CABLE BEND RELIEF, SIZE 1, IP50, 8 CONTACTS, 0° KEY



Technical information

| | | |
|---|--------------------------------|--|
| Max. creepage and air clearance distance | 0.5 mm (Contact to contact) | 0.5 mm (Contact to housing) |
| Nominal current single contact | 6.0 A | IEC 60512-5-2:2002 (DIN EN 60512-5-2:2003) |
| Nominal current insert (per individual contact) | 3.9 A | VDE 0298-4:2003 |
| Test voltage | 1.0 kV DC | SAE AS 13441:1998 method 3001.1 |

All shown connectors are rated to a safety extra low voltage (SELV) of less than 50 V AC / 75 V DC, according to IEC 61140:2016 (VDE 0140-1:2016) Protection against electric shock - Common aspects for installation and equipment. In case other standards rule a specific use of the connector, the application specific safety criteria shall be considered first. In this context, lower voltage ratings may be valid. Warning: Danger to life for operating voltages above 50 V AC / 120 V DC!

Mechanical and Environmental data

| | |
|-----------------------|---------------|
| Degree of protection* | IP50 |
| Operating temperature | -40°C - 120°C |
| Mating cycles | 5000 |

*mated & unmated condition

Material and Surface Treatments

| | |
|---------|----------------------------------|
| Housing | Cu-alloy with matt chrome finish |
| Contact | Cu-alloy with gold finish |

ODU MINI-SNAP[®] SERIES L RIGHT-ANGLED PLUG FOR CABLE BEND RELIEF, SIZE 1, IP50, 8 CONTACTS, 0° KEY

General information

This product requires the purchase of a cable bend relief.

All shown connectors are defined without breaking capacity (COC) according to IEC 61984:2008 (VDE 0627:2009).

The respective selected ODU connectors with data transfer functionality can transmit common data transmission such as HDMI[®] 2.0, USB[®] 3.2 Gen 1x1, FireWire[®] and eSATA[®], but they are not HDMI[®]-, USB[®]-, FireWire[®]- and eSATA[®]-standard connectors.

ODU MEDI-SNAP[®] and MINI-SNAP[®] is UL-approved (E110586).

ODU reserves the right to make changes based on the current state of knowledge without prior notice without being obliged to provide replacement deliveries or refinements of older designs.