

6W isolated DC-DC converter in 1x1 inch
Wide input voltage and regulated dual/single output



UL US CE CB Patent Protection RoHS

FEATURES

- Wide 2:1 input voltage range
- High efficiency up to 88%
- No-load power consumption as low as 0.12W
- I/O test isolation voltage 1.5k VDC
- Input under-voltage protection, output short-circuit, over-current, over-voltage protection
- Operating ambient temperature range: -40°C to +85°C
- Meet CISPR32/EN55032 CLASS A, without extra components
- Industry standard pin-out
- IEC60950, UL60950, EN60950 approved
- Meets EN62368 standard

VRA_YMD-6WR3 & VRB_YMD-6WR3 series of isolated 6W DC-DC converter with 2:1 input voltage with efficiencies of up to 88%, 1500VDC input to output isolation and the converter safely operate ambient temperature of -40°C to +85°C, input under-voltage protection, output over-voltage, over-current, short-circuit protection. They meet CLASS A of CISPR32/EN55032 EMI standards without external components, which make them widely applied in medical care, industrial control, electric power, instruments and communication fields.

Selection Guide

Certification	Part No.	Input Voltage (VDC)		Output		Full Load Efficiency ^② (%) Min./Typ.	Capacitive Load (µF) Max. ^③
		Nominal (Range)	Max. ^①	Voltage (VDC)	Current (mA) Max./Min.		
UL/CE/ CB	VRA1205YMD-6WR3	12 (9-18)	20	±5	±600/0	79/81	470
	VRA1212YMD-6WR3			±12	±250/0	83/85	100
--	VRA1215YMD-6WR3			±15	±200/0	81/83	100
CE	VRB1205YMD-6WR3			5	1200/0	79/81	1000
	VRB1212YMD-6WR3			12	500/0	83/85	470
UL/CE/ CB	VRA2405YMD-6WR3			24 (18-36)	40	±5	±600/0
	VRA2412YMD-6WR3	±12	±250/0			85/87	100
	VRA2415YMD-6WR3	±15	±200/0			85/87	100
CE	VRB2403YMD-6WR3	3.3	1500/0			75/77	1800
	VRB2405YMD-6WR3	5	1200/0			80/82	1000
--	VRB2409YMD-6WR3	9	667/0			83/85	470
CE	VRB2412YMD-6WR3	12	500/0			83/85	470
	VRB2415YMD-6WR3	15	400/0			84/86	220
	VRB2424YMD-6WR3	24	250/0			83/85	100
--	VRB4803YMD-6WR3	48 (36-75)	80	3.3	1500/0	77/79	1800
	VRB4805YMD-6WR3			5	1200/0	81/83	1000
	VRB4812YMD-6WR3			12	500/0	85/87	470
	VRB4815YMD-6WR3			15	400/0	86/88	220
	VB4824YMD-6WR3			24	250/0	86/88	100

Notes:
 ① Exceeding the maximum input voltage may cause permanent damage;
 ② Efficiency is measured at nominal input voltage and rated output load;
 ③ The specified maximum capacitive load value for positive and negative output is identical.

Input Specifications

Item	Operating Conditions	Min.	Typ.	Max.	Unit	
Input Current (full load / no-load)	12VDC nominal input series, nominal input voltage	--	617/10	633/22	mA	
	24VDC nominal input series, nominal input voltage	3.3VDC output	--	268/5		275/15
		Others	--	305/5		313/15
	48VDC nominal input series, nominal input voltage	3.3VDC output	--	130/4		134/8
Others		--	150/4	155/8		

Reflected Ripple Current		--	20	--	mA
Surge Voltage (1sec. max.)	12VDC nominal input series	-0.7	--	25	VDC
	24VDC nominal input series	-0.7	--	50	
	48VDC nominal input series	-0.7	--	100	
Start-up Voltage	12VDC nominal input series	--	--	9	
	24VDC nominal input series	--	--	18	
	48VDC nominal input series	--	--	36	
Input Under-voltage Protection	12VDC nominal input series	5.5	6.5	--	
	24VDC nominal input series	12	15.5	--	
	48VDC nominal input series	26	30	--	
Input Filter		Pi filter			
Hot Plug		Unavailable			

Output Specifications

Item	Operating Conditions		Min.	Typ.	Max.	Unit
Voltage Accuracy	5%-100% load		--	±1	±3	%
	0%-5% load	±5VDC output	--	±2	±5	
		others	--	±1	±3	
Linear Regulation	Input voltage variation from low to high at full load	Vo1	--	±0.2	±0.5	
		Vo2	--	±0.5	±1	
Load Regulation ^①	5%-100% load	Vo1	--	±0.5	±1	
		Vo2	--	±0.5	±1.5	
Cross Regulation	Vo1 load at 50%, Vo2 load at range of 10%-100%		--	--	±5	
Transient Recovery Time			--	300	500	μs
Transient Response Deviation	25% load step change	3.3VDC, 5VDC, ±5VDC output	--	±5	±8	%
		Others	--	±3	±5	
Temperature Coefficient	Full load		--	--	±0.03	%/°C
Ripple & Noise ^②	20MHz bandwidth, 5%-100% load		--	60	85	mV p-p
Over-voltage Protection			110	--	160	%Vo
Over-current Protection	Input voltage range		110	140	190	%Io
Short-circuit Protection			Continuous, self-recovery			

Note: ① Load regulation for 0%-100% load is ±5%;
② ripple & noise at ≤ 5% load is 5%Vo Max. The "parallel cable" method is used for ripple and noise test, please refer to DC-DC Converter Application Notes for specific information.

General Specification

Item	Operating Conditions	Min.	Typ.	Max.	Unit
Isolation	Input-output Electric Strength Test for 1 minute with a leakage current of 1mA max.	1500	--	--	VDC
Insulation Resistance	Input-output resistance at 500VDC	1000	--	--	MΩ
Isolation Capacitance	Input-output capacitance at 100KHz/0.1V	--	1000	--	pF
Operating Temperature	See Fig. 1	-40	--	+85	°C
Storage Humidity	Non-condensing	5	--	95	%RH
Storage Temperature		-55	--	+125	°C
Pin Soldering Resistance Temperature	Soldering spot is 1.5mm away from case for 10 seconds	--	--	+300	
Vibration		10-55Hz, 2G, 30 Min. along X, Y and Z			
Switching Frequency *	PWM mode	--	300	--	KHz
MTBF	MIL-HDBK-217F@25°C	1000	--	--	K hours

Note: *Switching frequency is measured at full load. The module reduces the switching frequency for light load (below 50%) efficiency improvement.

Mechanical Specifications

Case Material	Aluminum alloy
Dimensions	25.40 x 25.40 x 11.70 mm
Weight	12.5g(Typ.)
Cooling method	Free air convection

Electromagnetic Compatibility (EMC)

Emissions	CE	12VDC, 24VDC nominal input series	CISPR32/EN55032	CLASS A (without extra components)/ CLASS B (see Fig.3-② for recommended circuit)	
		48VDC nominal input series	CISPR32/EN55032	CLASS B (see Fig.3-② for recommended circuit)	
	RE	12VDC, 24VDC nominal input series	CISPR32/EN55032	CLASS A (without extra components)/ CLASS B (see Fig.3-② for recommended circuit)	
		48VDC nominal input series	CISPR32/EN55032	CLASS B (see Fig.3-② for recommended circuit)	
Immunity	ESD		IEC/EN61000-4-2	Contact ±4KV	perf. Criteria B
	RS		IEC/EN61000-4-3	10V/m	perf. Criteria A
	EFT		IEC/EN61000-4-4	±2KV (see Fig.3-① for recommended circuit)	perf. Criteria B
	Surge		IEC/EN61000-4-5	line to line ±2KV (see Fig.3-① for recommended circuit)	perf. Criteria B
	CS		IEC/EN61000-4-6	3 Vr.m.s	perf. Criteria A
	Voltage dips, short interruptions and voltage variations immunity		IEC/EN61000-4-29	0%, 70%	perf. Criteria B

Typical Characteristic Curves

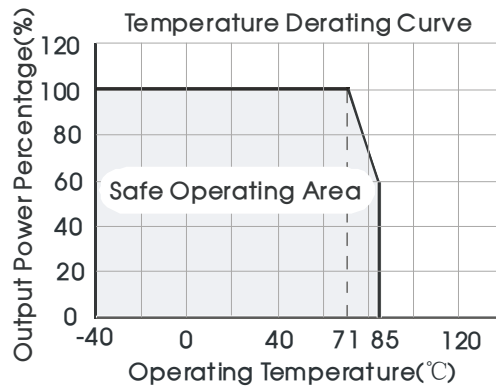
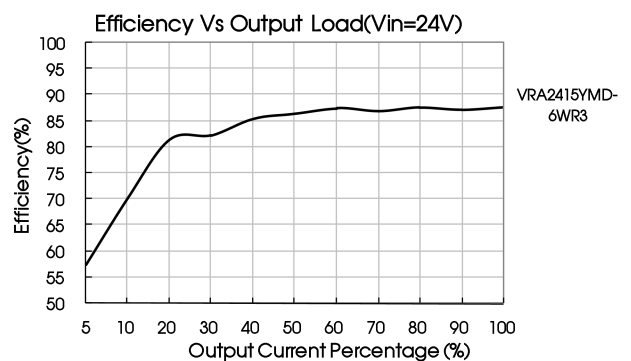
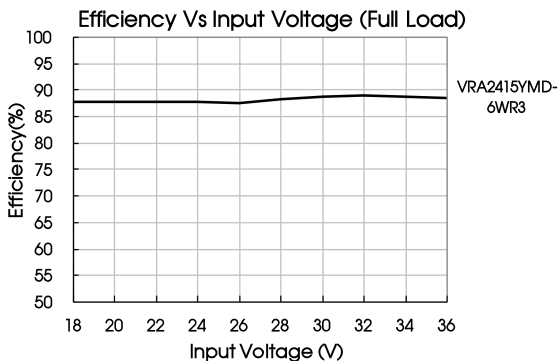
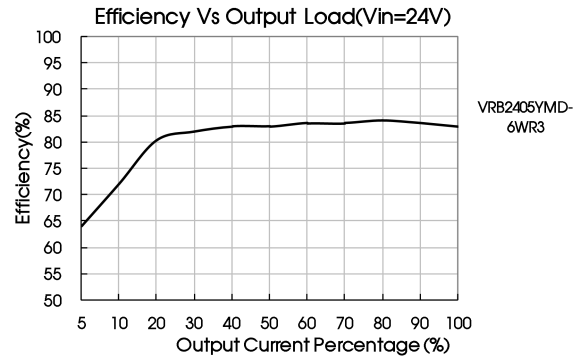
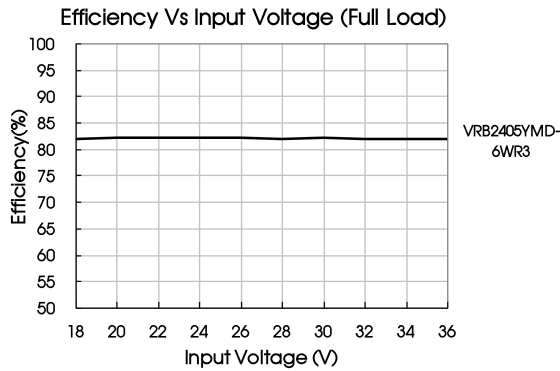

Fig. 1





Design Reference

1. Typical application

All the DC/DC converters of this series are tested before delivery using the recommended circuit shown in Fig. 2.

Input and/or output ripple can be further reduced by appropriately increasing the input & output capacitor values C_{in} and C_{out} and/or by selecting capacitors with a low ESR (equivalent series resistance). Also make sure that the capacitance is not exceeding the specified max. capacitive load value of the product.

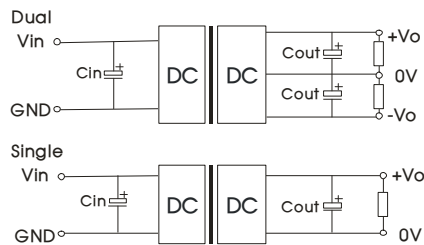

Fig. 2

Vin(VDC)	Cin(uF)	Cout(uF)
12	100µF/25V	Vo(3/±3/5/±5/9/±9):10µF/16V Vo(12/±12/15/±15V):10µF/25V
24	10 - 47µF/50V	Vo(24/±24V):10µF/50V
48	100µF/100V	

2. EMC compliance circuit

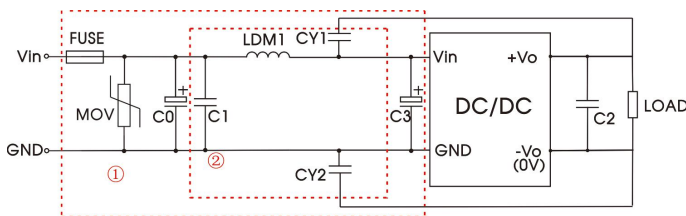

Fig. 3

Notes: For EMC tests we use Part ① in Fig. 3 for immunity and part ② for emissions test. Selecting based on needs.

Parameter description

Model	Vin:12V	Vin:24V	Vin:48V
FUSE	Choose according to actual input current		
MOV	S14K20	S20K30	14D101K
C0	1000µF/35V	1000µF/50V	330µF/100V
C1	1µF/50V		4.7µF/100V
C2	Refer to the Cout in Fig.2		
C3	330µF/35V	330µF/50V	330µF/100V
LDM1	4.7µH		
CY1/CY2	1nF/2KV		

3. The products do not support parallel connection of their output

4. For additional information please refer to DC-DC converter application notes on www.mornsun-power.com

Dimensions and Recommended Layout

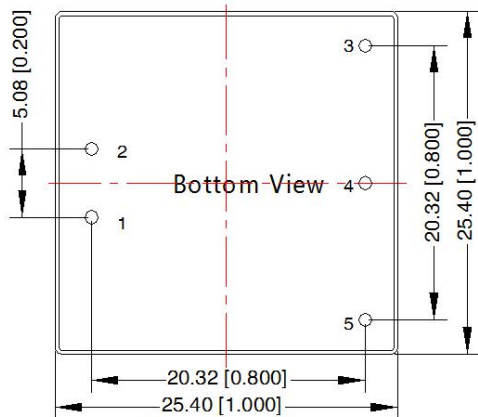
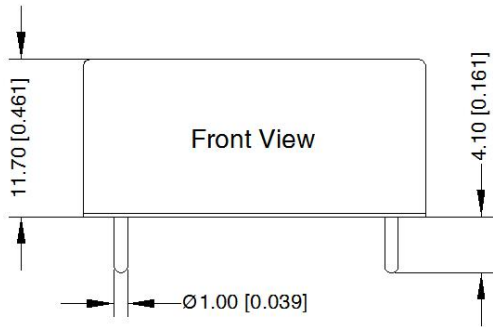

Note:
Unit: mm[inch]
Pin diameter tolerances: $\pm 0.10 [\pm 0.004]$
General tolerances: $\pm 0.50 [\pm 0.020]$

THIRD ANGLE PROJECTION

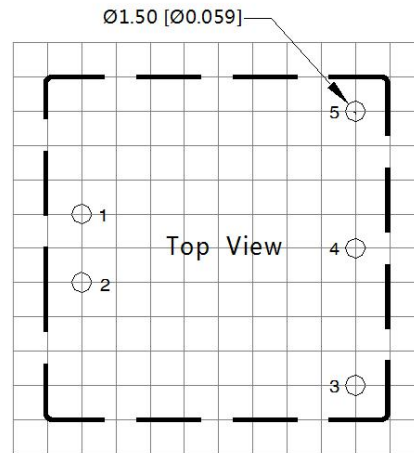

Note: Grid 2.54*2.54mm

Pin-Out		
Pin	Single	Dual
1	GND	GND
2	Vin	Vin
3	+Vo	+Vo
4	No Pin	0V
5	0V	-Vo

Note:

- For additional information on Product Packaging please refer to www.mornsun-power.com. Packaging bag number: 58210003;
- The recommended unbalance degree of the dual output module load is $\leq \pm 5\%$; if the degree exceeds $\pm 5\%$, than the product performance cannot be guaranteed to comply with all parameters in the datasheet. Please contact our technicians directly for specific information;
- The maximum capacitive load offered were tested at input voltage range and full load;
- Unless otherwise specified, parameters in this datasheet were measured under the conditions of $T_a = 25^\circ\text{C}$, humidity $< 75\% \text{RH}$ with nominal input voltage and rated output load;
- All index testing methods in this datasheet are based on company corporate standards;
- We can provide product customization service, please contact our technicians directly for specific information;
- Products are related to laws and regulations: see "Features" and "EMC";
- Our products shall be classified according to ISO14001 and related environmental laws and regulations, and shall be handled by qualified units.

Mornsun Guangzhou Science & Technology Co., Ltd.

Address: No. 5, Kehui St. 1, Kehui Development Center, Science Ave., Guangzhou Science City, Huangpu District, Guangzhou, P. R. China
Tel: 86-20-38601850 Fax: 86-20-38601272 E-mail: info@mornsun.cn www.mornsun-power.com