

LTE+WIFI Combination Antenna JCG010LW

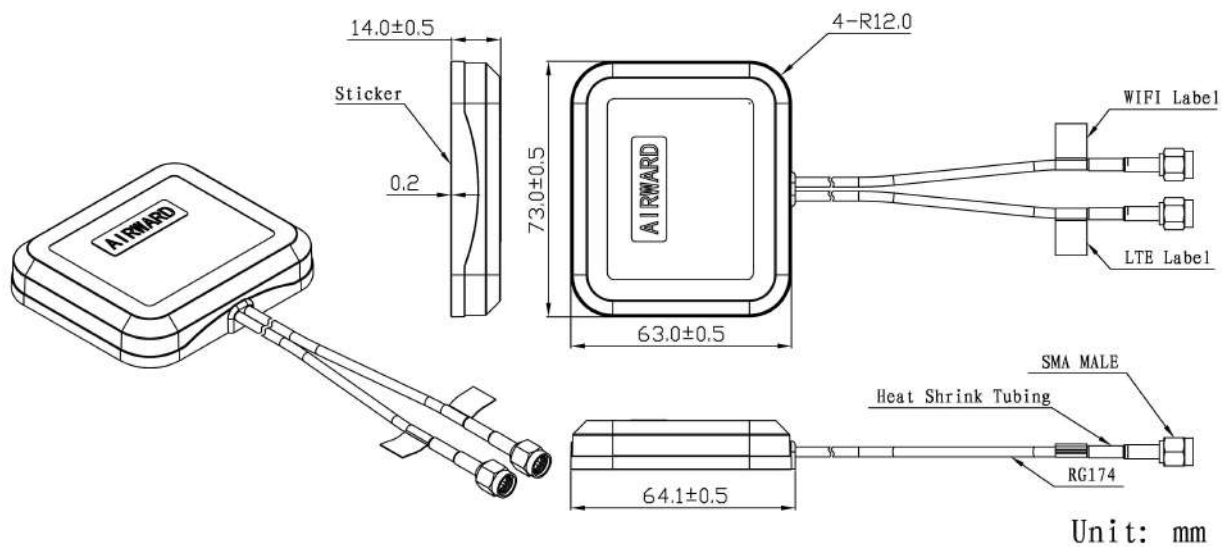

DIMENSIONS



SPECIFICATIONS

Item	Specifications	
LTE Antenna	Frequency Range	698~960MHz/1710~2690MHz
	V.S.W.R (min)	<3.0
	Polarization	Linear
	Gain	2dBi
	Impedance	50Ω
WIFI Antenna	Frequency Range	2400~2500MHz/4900~5825MHz
	V.S.W.R (min)	<2.0
	Polarization	Linear
	Gain	3dBi
	Impedance	50Ω
Mechanical	Cable	RG174
	Connector	SMA or others
	Radome Material	ABS
	Mounting Method	Adhesive/Magnet
Environmental	Operating Temperature	-40°C~+85°C
	Relative Humidity	Up to 95%
	Ingress Protection	IP66
	Vibration	10 to 55Hz with 1.5mm amplitude 2hours
	Environmentally Friendly	ROHS Compliant

Radiation Pattern

LTE Antenna



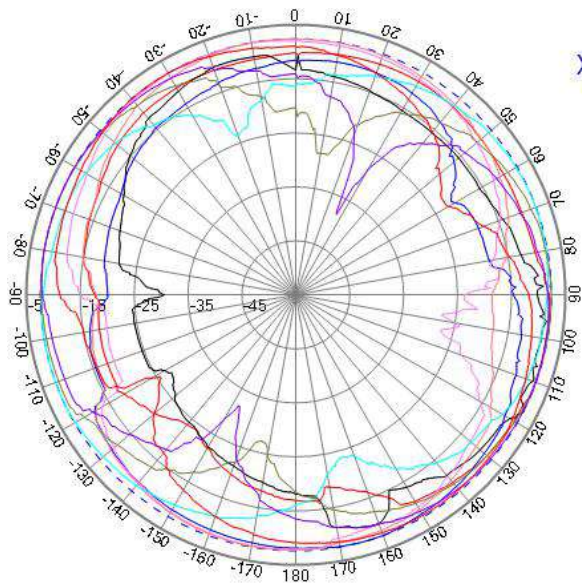

- 测试频率: 700
- 测试频率: 824
- 测试频率: 868
- 测试频率: 960
- 测试频率: 1710
- 测试频率: 1850
- 测试频率: 1990
- 测试频率: 2170
- 测试频率: 2690

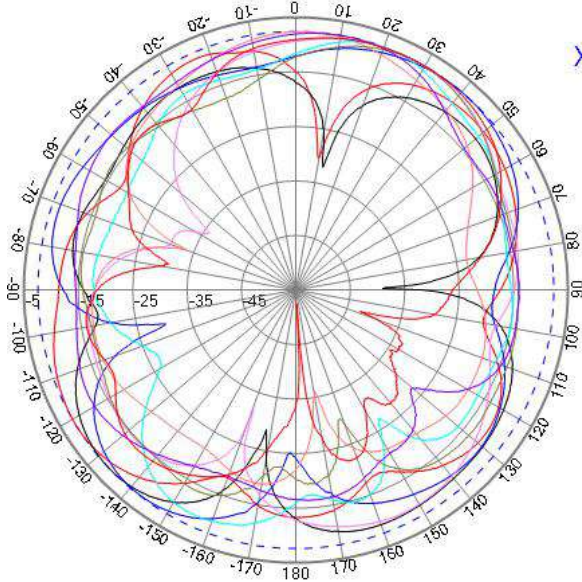

- 测试频率: 700
- 测试频率: 824
- 测试频率: 868
- 测试频率: 960
- 测试频率: 1710
- 测试频率: 1850
- 测试频率: 1990
- 测试频率: 2170
- 测试频率: 2690

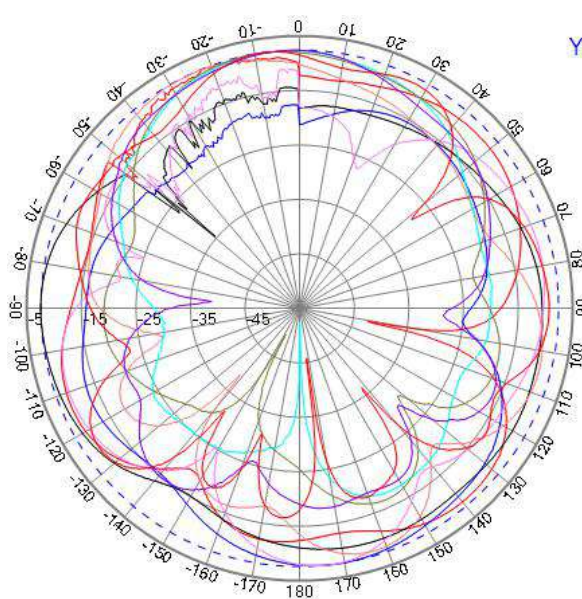

- 测试频率: 700
- 测试频率: 824
- 测试频率: 868
- 测试频率: 960
- 测试频率: 1710
- 测试频率: 1850
- 测试频率: 1990
- 测试频率: 2170
- 测试频率: 2690

WIFI Antenna

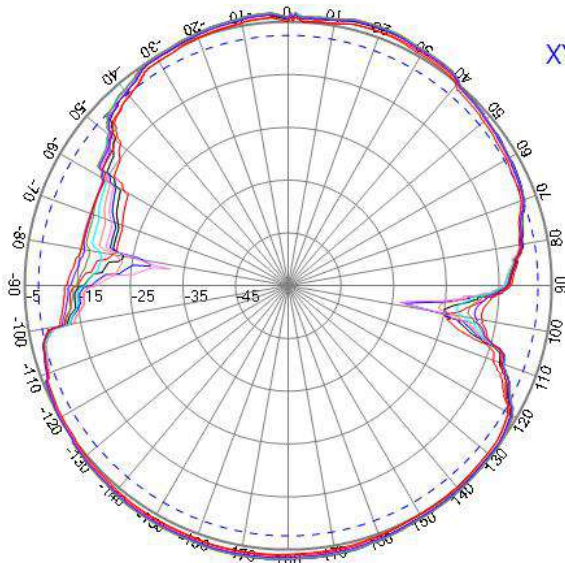

- 测试频率: 2400
- 测试频率: 2410
- 测试频率: 2420
- 测试频率: 2430
- 测试频率: 2440
- 测试频率: 2450
- 测试频率: 2460
- 测试频率: 2470
- 测试频率: 2483

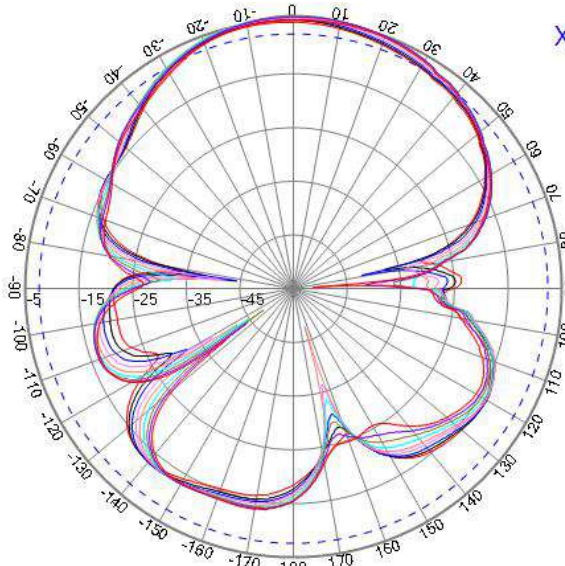

- 测试频率: 2400
- 测试频率: 2410
- 测试频率: 2420
- 测试频率: 2430
- 测试频率: 2440
- 测试频率: 2450
- 测试频率: 2460
- 测试频率: 2470
- 测试频率: 2483

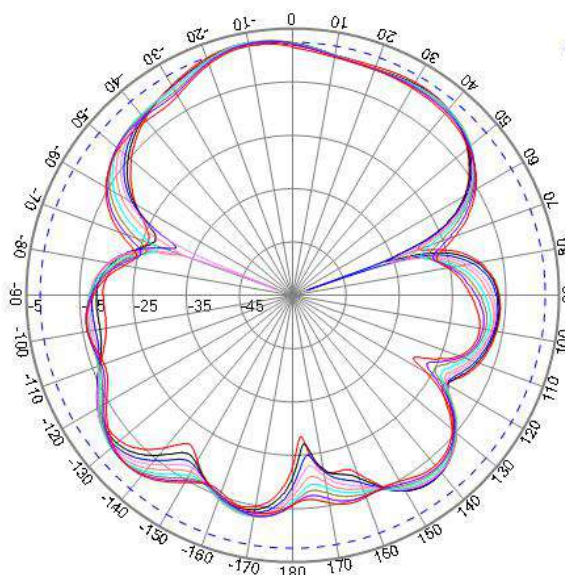

- 测试频率: 2400
- 测试频率: 2410
- 测试频率: 2420
- 测试频率: 2430
- 测试频率: 2440
- 测试频率: 2450
- 测试频率: 2460
- 测试频率: 2470
- 测试频率: 2483