

# DC/DC Converter

## PV15-27BxxR3 Series

15W isolated DC-DC converter with ultra-wide, ultra-high 100-1000V DC input for Renewable Energy



## FEATURES

- Input voltage up to 1200VDC (Transient, duration: 60s)
- Wide 10:1 input voltage range of 100 -1000VDC
- Industrial grade operating temperature -40°C to +70°C
- High I/O isolation test voltage of 4000VAC
- High efficiency, low ripple & noise
- Input reverse polarity protection, output short circuit, over-current, over-voltage protection
- High reliability, long service life
- Mounting options available for PCB mounting, chassis mounting and DIN-Rail mounting
- Reinforced insulation
- Customization is available

PV15-27BxxR3 series are regulated DC-DC converters with an ultra-wide and ultra-high DC input of 100-1000VDC. The products feature high efficiency, high reliability, high insulation and a high level of safety protection. This type of power supply is widely used in renewable energy industries such as photovoltaic, power generation, energy storage, inverters and high-voltage DC conversions. The converters provide multiple protection features and guarantee stable and safe operating environments even under abnormal working conditions. For extremely harsh EMC environment, we recommend using the application circuit show in Design Reference of this datasheet.

## Selection Guide

Certification	Model*	Output Power	Nominal Output Voltage and Current (Vo/Io)	Efficiency at 200VDC (% Typ.)	Capacitive Load (µF) Max.
EN	PV15-27B12R3	15W	12V/1.25A	81	2000
	PV15-27B15R3		15V/1.00A	81	1200
	PV15-27B24R3		24V/0.625A	83	470

Note: \*Use suffix "A2C" for chassis mounting and suffix "A4C" for DIN-Rail mounting.

## Input Specifications

Item	Operating Conditions	Min.	Typ.	Max.	Unit
Input Voltage Range		100	--	1000	VDC
	Transient (60s)	--	--	1200	
Input Current	200VDC	--	--	120	mA
	600VDC	--	--	40	
	1000VDC	--	--	22	
Inrush Current	200VDC	--	7	--	A
	600VDC	--	20	--	
	1000VDC	--	30	--	
Input Under-voltage Protection	Lockout activation range	60	--	85	VDC
	Lockout deactivation range	75	--	95	
Input Reverse Polarity Protection		Available			
External Input Fuse		2A/1000V, required			
Hot Plug		Unavailable			

Output Specifications

Item	Operating Conditions		Min.	Typ.	Max.	Unit
Output Voltage Accuracy			--	±1	±2	%
Line Regulation			--	±0.5	±1	
Load Regulation			--	±0.5	±1	
Ripple & Noise*	20MHz bandwidth (peak-to-peak value)		--	100	200	mV
Temperature Drift Coefficient			--	±0.02	±0.15	%/°C
Short Circuit Protection			Continuous, self-recovery			
Over-current Protection			≥110%Io self-recovery			
Over-voltage Protection	PV15-27B12R3		≤15VDC			Output voltage clamp or hiccup
	PV15-27B15R3		≤19VDC			
	PV15-27B24R3		≤28VDC			
Minimum Load			0	--	--	%
Start-up Delay Time	100-1000VDC		--	--	1	s
Hold-up Time	Room temperature, full load	600VDC input	--	10	--	ms
		1000VDC input	--	30	--	

Note: \* The "parallel cable" method is used for ripple and noise test, please refer to PV Converter Application Notes for specific information.

General Specifications

Item	Operating Conditions		Min.	Typ.	Max.	Unit
Isolation	Input-output	Electric Strength Test for 1min., leakage current <5mA	4000	--	--	VAC
Insulation Resistance	Input-output	At 500VDC	100	--	--	MΩ
Operating Temperature			-40	--	+70	°C
Storage Temperature			-40	--	+105	
Storage Humidity			--	--	95	%RH
Soldering Temperature	Wave-soldering		260±5°C; time: 5-10s			
	Manual-welding		360±10°C; time: 3-5s			
Switching Frequency			--	65	--	kHz
Power Derating	-40°C to -30°C	100-150VDC	4	--	--	% / °C
	+50°C to +70°C		2	--	--	
	100VDC- 200VDC		0.4	--	--	%/VDC
	2000m- 5000m		6.67	--	--	%/km
Safety Standard			EN62109-1; Design refer to UL1741, CSA-C22.2 No.107.H6			
MTBF			MIL-HDBK-217F@25°C > 300,000 h			

Mechanical Specifications

Case Material	Black flame-retardant and heat-resistant plastic (UL94V-0)	
Dimensions	Horizontal package	70.0 x 48.0 x 23.5 mm
	A2C chassis mounting	96.1 x 54.0 x 32.0 mm
	A4C DIN-Rail mounting	96.1 x 54.0 x 36.6 mm
Weight	Horizontal package	115g (Typ.)
	A2C chassis mounting	170g (Typ.)
	A4C DIN-Rail mounting	210g (Typ.)
Cooling method	Free air convection	

Electromagnetic Compatibility (EMC)

Emissions	CE	CISPR32/EN55032	CLASS A (See Fig. 2 for recommended circuit)	
	RE	CISPR32/EN55032	CLASS A	
Immunity	ESD	IEC/EN61000-4-2	Contact $\pm 6\text{KV}$ /Air $\pm 8\text{KV}$	Perf. Criteria B
	RS	IEC/EN61000-4-3	10V/m	perf. Criteria A
	EFT	IEC/EN61000-4-4	$\pm 4\text{KV}$	perf. Criteria B
	Surge	IEC/EN61000-4-5	line to line $\pm 1\text{KV}$	perf. Criteria B
			line to line $\pm 2\text{KV}$ (See Fig. 2 for recommended circuit)	perf. Criteria B
CS	IEC/EN61000-4-6	10Vr.m.s	perf. Criteria A	

Product Characteristic Curve

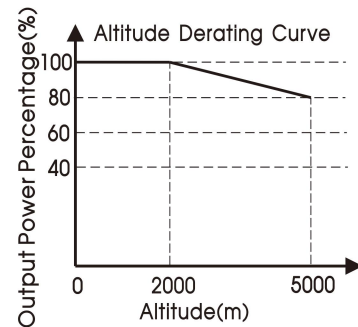
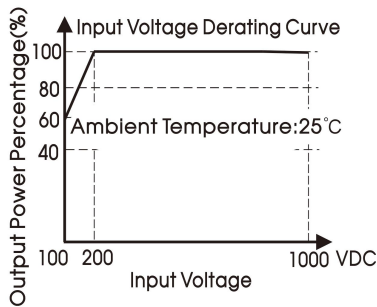
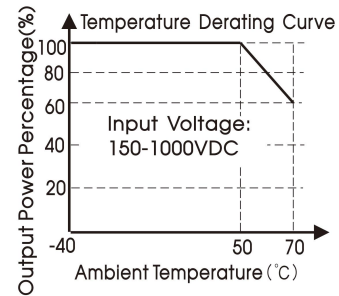
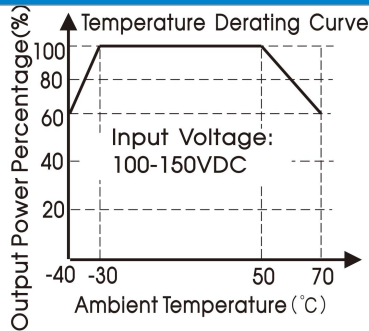

Note: ① With an input between 100 - 200VDC, the output power of PV15-27BxxR3 parts must be derated as per temperature derating curves;  
② This product is suitable for use in natural air cooling environments, if in a closed environment, please contact our company's FAE.

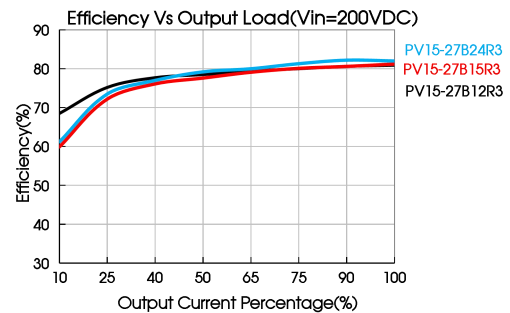
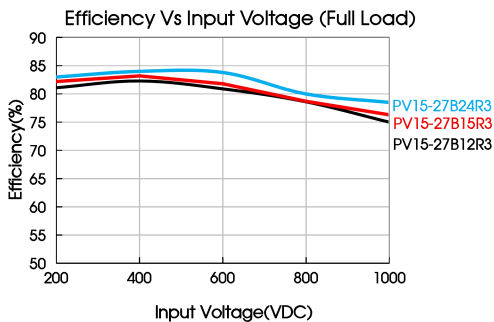

Design Reference

1. Typical application

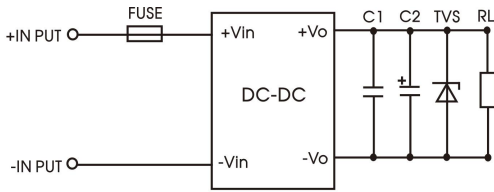

Model	FUSE	C1(μF)	C2(μF)	TVS
PV15-27B12R3	2A/1000VDC, required	1	120	SMBJ20A
PV15-27B15R3				SMBJ30A
PV15-27B24R3				SMBJ30A

Fig. 1: Typical application circuit

Note on filter components:

We recommend using an electrolytic capacitor with high frequency and low ESR rating for C2 (refer to manufacture's datasheet). Choose a capacitor voltage rating with at least 20% margin, in other words not exceeding 80%. C1 is a ceramic capacitor, used to filter high-frequency noise. TVS is a recommended suppressor diode to protect the application in case of a converter failure.

2. EMC compliance recommended circuit

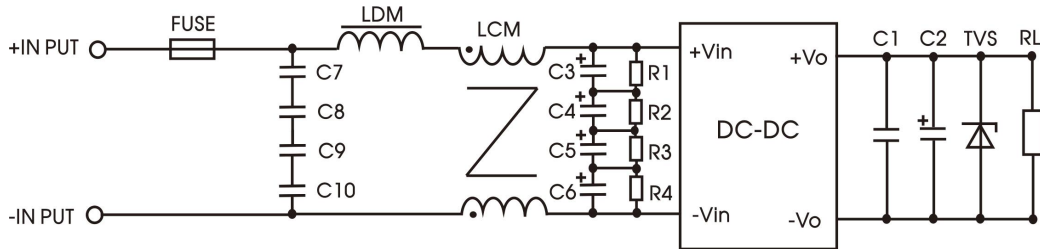
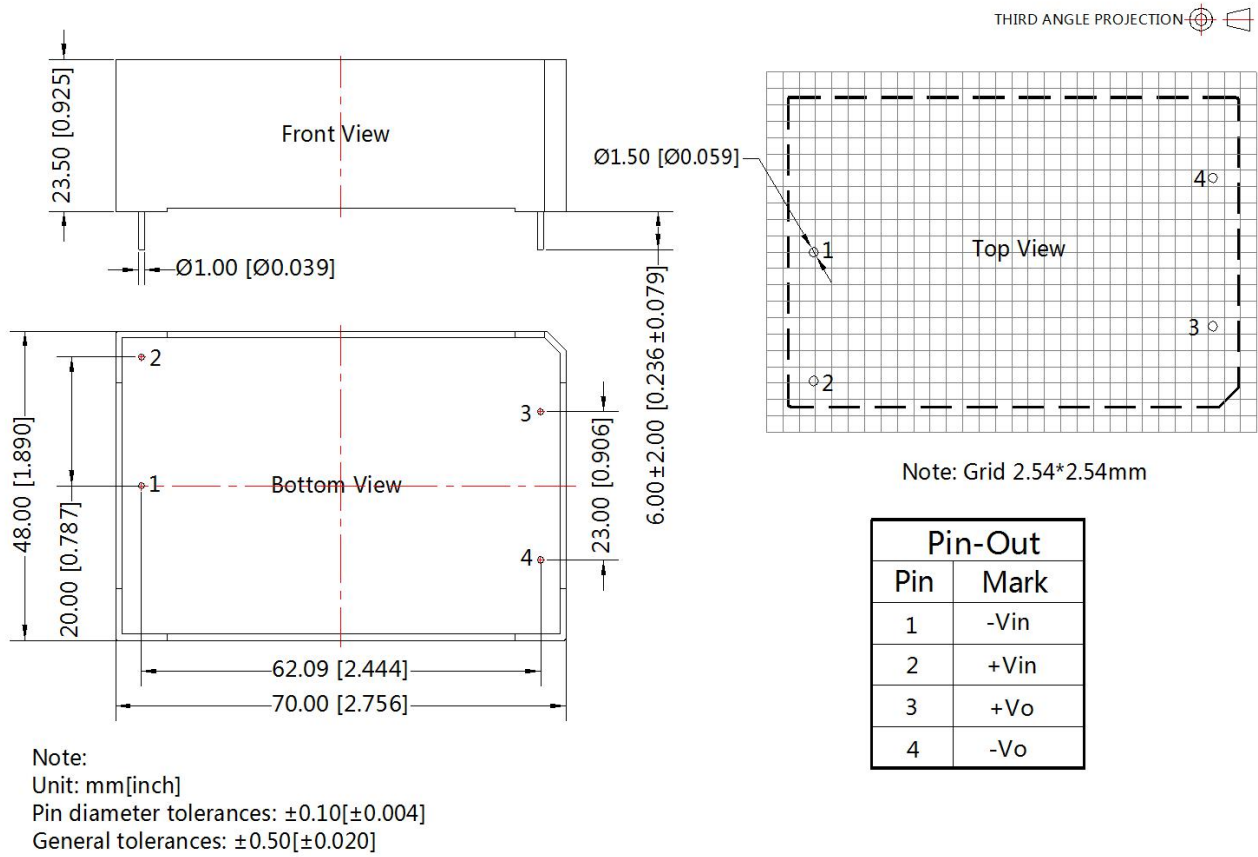

Fig 2: EMC application for higher compliance requirements (output parameters are show in Figure 1)

Component	Recommended value
C3/C4/C5/C6	10uF/400VDC
C7/C8/C9/C10	224K/275VAC
R1/R2/R3/R4	1MΩ/0.25W
LDM	1.2mH/0.38A
LCM	10mH
FUSE	2A/1000V, required

3. For additional information please refer to application notes on [www.mornsun-power.com](http://www.mornsun-power.com).

Dimensions and Recommended Layout



A2C Chassis Mounting Dimensions

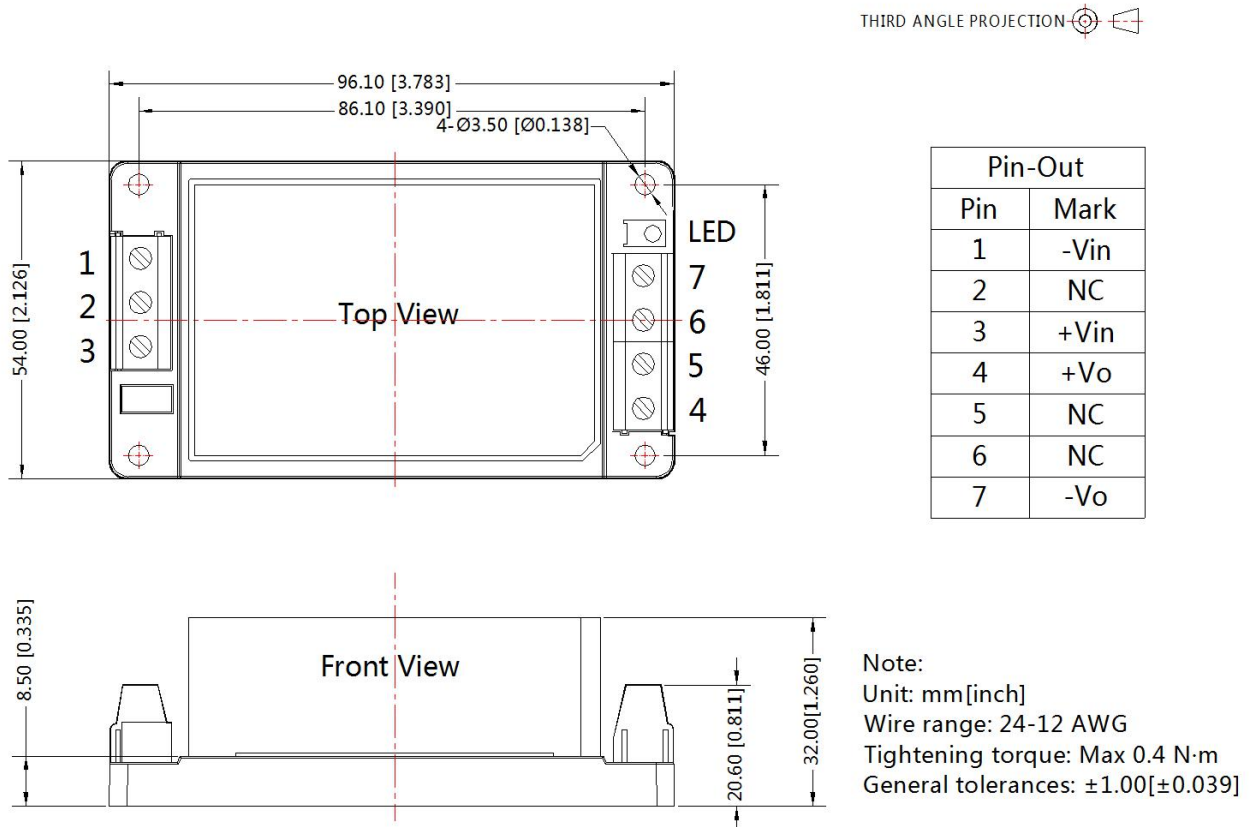

A4C Din-Rail mounting Dimensions

THIRD ANGLE PROJECTION 

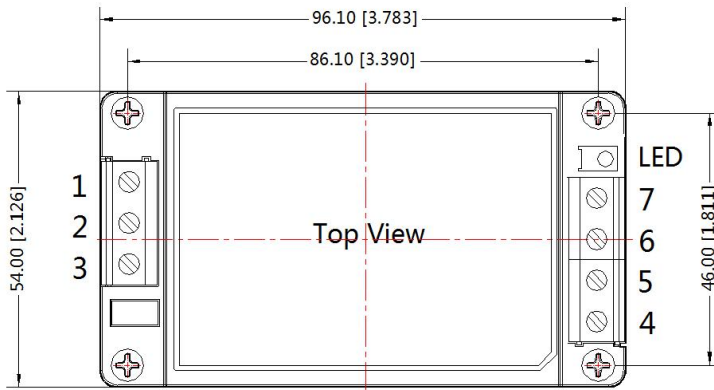

Pin-Out	
Pin	Mark
1	-Vin
2	NC
3	+Vin
4	+Vo
5	NC
6	NC
7	-Vo

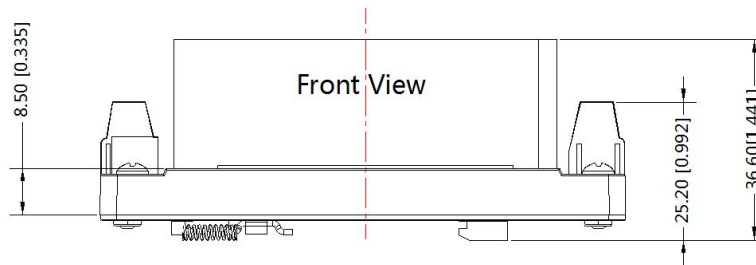

Note:

Unit: mm[inch]

Mounting rail: TS35, rail needs to

connect safety ground

Wire range: 24-12 AWG

Tightening torque: Max 0.4 N·m

General tolerances:  $\pm 1.00[\pm 0.039]$

Note:

1. For additional information on Product Packaging please refer to [www.mornsun-power.com](http://www.mornsun-power.com). Packaging bag number: 58220006; the packaging bag number of A2C/A4C package: 58220192;
2. Unless otherwise specified, parameters in this datasheet were measured under the conditions of  $T_a=25^\circ\text{C}$ , humidity<75% with nominal input voltage and rated output load;
3. All index testing methods in this datasheet are based on our company corporate standards;
4. We can provide product customization service, please contact our technicians directly for specific information;
5. Specifications are subject to change without prior notice.

Mornsun Guangzhou Science & Technology Co., Ltd.

Address: No. 5, Kehui St. 1, Kehui Development Center, Science Ave., Guangzhou Science City, Huangpu District, Guangzhou, P. R. China  
Tel: 86-20-38601850 Fax: 86-20-38601272 E-mail: [info@mornsun.cn](mailto:info@mornsun.cn) [www.mornsun-power.com](http://www.mornsun-power.com)