

20W, AC-DC converter



UL62368-1



EN62368-1

EN61558-1

EN60335-1

CB Report

RoHS



FEATURES

- Ultra-wide 85 - 305VAC and 100 - 430VDC input voltage range
- Operating ambient temperature range: -40°C to +85°C
- Up to 87% efficiency
- No-load power consumption 0.1W
- 5000m altitude application
- Over-voltage category OVC III (meet EN61558)
- Plastic case meets UL94V-0 flammability
- EMI performance meets CISPR32/EN55032 CLASS B, EN55014

LD20-23BxxR2 series AC-DC converters is one of Mornsun's new generation compact size power converter. It features ultra-wide AC input and at the same time accepts DC input voltage, low power consumption, low ripple & noise, high efficiency, high reliability, reinforced isolation. It offers good EMC performance compliant to IEC/EN61000-4 and CISPR32/EN55032 and meets IEC/EN/UL62368/EN60335/EN61558/IEC/EN60601-1/ANSI/AAMI ES60601-1 standards. The converters are widely used in industrial, power, medical treatment, home appliances, instrumentation, communication and civil applications. For extremely harsh EMC environment, we recommend using the application circuit show in Design Reference of this datasheet.

Selection Guide

Certification	Part No.*	Output Power	Nominal Output Voltage and Current	Efficiency at 230VAC (%) Typ.	Capacitive Load (uF) Max.
UL/EN/IEC	LD20-23B03R2	14.85W	3.3V/4500mA	81	8000
	LD20-23B05R2	20W	5V/4000mA	85	8000
	LD20-23B09R2		9V/2200mA	84	5400
	LD20-23B12R2		12V/1670mA	86	4000
	LD20-23B15R2		15V/1330mA	87	3000
	LD20-23B24R2		24V/830mA	87	1000

Note: * Use suffix "A2S" for chassis and suffix "A4S" for DIN-Rail mounting.

Input Specifications

Item	Operating Conditions	Min.	Typ.	Max.	Unit
Input Voltage Range	AC input	85	--	305	VAC
	DC input	100	--	430	VDC
Input Frequency		47	--	440	Hz
Input Current	115VAC	--	--	0.5	A
	230VAC	--	--	0.3	
Inrush Current	115VAC	--	20	--	
	230VAC	--	45	--	
Leakage Current	277VAC/50Hz	0.1mA RMS Max.			
Built In Fuse		3.15A/300V, slow-blow			
Hot Plug		Unavailable			

Output Specifications

Item	Operating Conditions	Min.	Typ.	Max.	Unit
Output Voltage Accuracy		--	±1.5	--	%
Line Regulation	Full load	--	±0.5	--	
Load Regulation	0%-100% load	--	±1	--	
Ripple & Noise*	20MHz bandwidth (peak-to-peak value)	--	100	150	mV

Stand-by Power Consumption	230VAC	3.3/5/9/12/15V	--	0.10	--	W
		24V	--	0.12	--	
Temperature Coefficient			--	±0.02	--	%/°C
Short Circuit Protection			Hiccup, continuous, self-recovery			
Over-current Protection			≥110%Io, self-recovery			
Over-voltage Protection		3.3/5V output	≤7.5VDC (Output voltage clamp or hiccup)			
		9V output	≤16VDC (Output voltage clamp or hiccup)			
		12/15V output	≤20VDC (Output voltage clamp or hiccup)			
		24V output	≤30VDC (Output voltage clamp or hiccup)			
Minimum Load			0	--	--	%
Hold-up Time		115VAC input	--	8	--	ms
		230VAC input	--	50	--	

Note: *The "Tip and barrel method" is used for ripple and noise test, output parallel 10uF electrolytic capacitor and 1uF ceramic capacitor, please refer to AC-DC Converter Application Notes for specific information.

General Specifications

Item		Operating Conditions	Min.	Typ.	Max.	Unit	
Isolation	Input-output	Electric Strength Test for 1min., leakage current <5 mA	4000	--	--	VAC	
Insulation Resistance	Input - output	At 500VDC	100	--	--	MΩ	
Operating Temperature			-40	--	+85	°C	
Storage Temperature			-40	--	+85		
Storage Humidity			--	--	95	%RH	
Soldering Temperature		Wave-soldering	260 ± 5°C; time: 5 - 10s				
		Manual-welding	360 ± 10°C; time: 3 - 5s				
Switching Frequency			--	65	--	kHz	
Power Derating		-40°C to -25°C	85VAC-165VAC	2.0	--	--	% / °C
		+50°C to +70°C	3.3/5/9V	2.5	--	--	
		+55°C to +70°C	12/15/24V	3.33	--	--	
		+70°C to +85°C		1.33	--	--	% / VAC
		85VAC - 100VAC		2.0	--	--	
		277VAC - 305VAC		0.71	--	--	
	2000m - 5000m		6.7	--	--	% / Km	
Safety Standard			IEC/UL62368-1, EN61558-1, EN60335-1 Safety Approval & EN62368-1 (Report); Design refer to IEC/EN60601-1/ANSI/AAMI ES60601-1				
Safety Class			CLASS II				
MTBF			MIL-HDBK-217F@25°C > 1,500,000 h				
Designed life	230VAC	Ta: 25°C 100% load	> 130x10 ³ h				
		Ta: 55°C 100% load	> 16x10 ³ h				
		Ta: 55°C 80% load	> 27x10 ³ h				

Mechanical Specifications

Case Material		Black plastic, flame-retardant and heat-resistant (UL94V-0)
Dimension	DIP package	52.40 x 27.20 x 24.00 mm
	A2S chassis mounting	76.00 x 31.50 x 32.80 mm
	A4S Din-Rail mounting	76.00 x 31.50 x 37.40 mm
Weight	DIP package	55g (Typ.)
	A2S chassis mounting	75g (Typ.)
	A4S Din-Rail mounting	95g (Typ.)
Cooling method		Free air convection

Electromagnetic Compatibility (EMC)

Emissions	CE	CISPR32/EN55032 CLASS B	
		CISPR32/EN55032 CLASS B (See Fig.3 for recommended circuit)	
		CISPR11/EN55011 CLASS B	
	RE	EN55014-1	
		CISPR32/EN55032 CLASS B	
		CISPR32/EN55032 CLASS B (See Fig.3 for recommended circuit)	
Flicker	CISPR11/EN55011 CLASS B		
	EN55014-1		
Immunity	ESD	IEC/EN 61000-4-2 Contact ±6KV / Air ±8KV	Perf. Criteria A
		IEC/EN55014-2	Perf. Criteria A
	RS	IEC/EN61000-4-3 10V/m	perf. Criteria A
		IEC/EN55014-2	perf. Criteria A
	EFT	IEC/EN61000-4-4 ±2KV	perf. Criteria A
		IEC/EN61000-4-4 ±4KV (See Fig.2, Fig.3 for recommended circuit)	perf. Criteria A
		IEC/EN55014-2	perf. Criteria A
	Surge	IEC/EN61000-4-5 line to line ±1KV	perf. Criteria A
		IEC/EN61000-4-5 line to line ±2KV (See Fig.2 for recommended circuit)	perf. Criteria A
		IEC/EN61000-4-5 line to line ±2KV/line to ground ±4KV (See Fig.3 for recommended circuit)	perf. Criteria A
		IEC/EN55014-2	perf. Criteria A
	CS	IEC/EN61000-4-6 10Vr.m.s	perf. Criteria A
		IEC/EN55014-2	perf. Criteria A
	PFMF	IEC/EN6100-4-8 10A/m	perf. Criteria A
IEC/EN55014-2		perf. Criteria A	
Voltage dip, short interruption and voltage variation	IEC/EN61000-4-11 0%, 70%	perf. Criteria B	
	IEC/EN55014-2	perf. Criteria B	

Note: When the output terminal of the product needs to be connected to PE through a Y capacitor, or close to the metal frame, please refer to the Fig.3 for recommended circuit.

Product Characteristic Curve

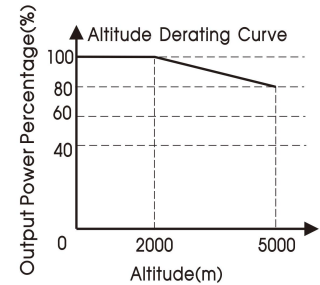
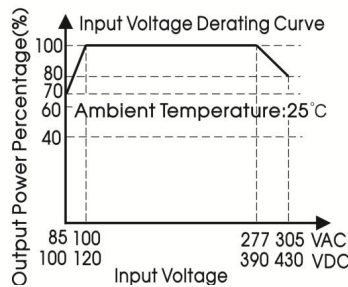
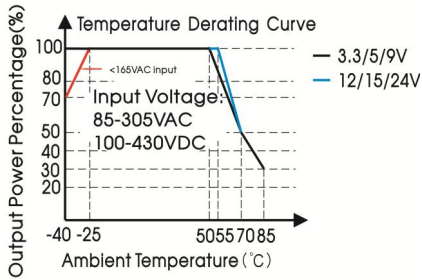

Note: ① With an AC input between 85-100V/277-305VAC and a DC input between 100-120V/390-430VDC, the output power must be derated as per temperature derating curves;

② This product is suitable for applications using natural air cooling; for applications in closed environment please consult factory or one of our FAE.

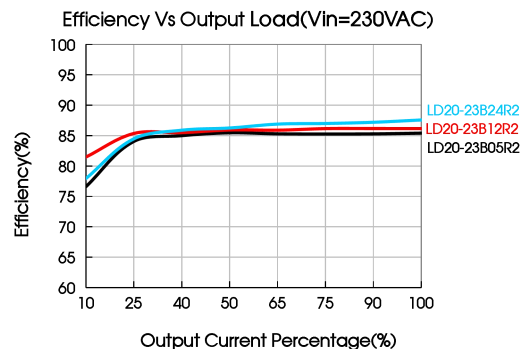
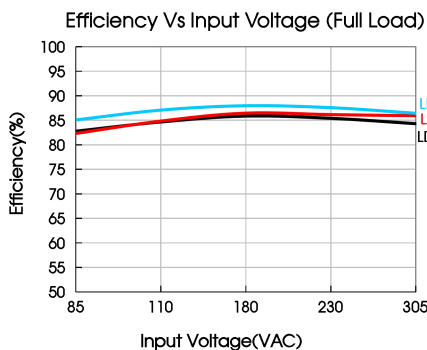

Design Reference

1. Typical application

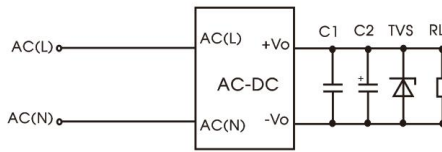

Fig. 1: Typical circuit diagram

Part No.	C1	C2	TVS
LD20-23B03R2	10uF/50V	10uF/16V	SMBJ7.0A
LD20-23B05R2		10uF/16V	SMBJ7.0A
LD20-23B09R2		10uF/25V	SMBJ12A
LD20-23B12R2		10uF/25V	SMBJ20A
LD20-23B15R2		10uF/25V	SMBJ20A
LD20-23B24R2		10uF/35V	SMBJ30A

Output Filter Components:

C1 is a ceramic capacitor used for filtering high-frequency noise and TVS is a recommended suppressor diode to protect the application in case of a converter failure.

2. EMC compliance recommended circuit

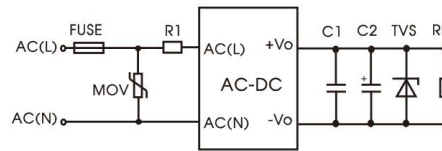

Fig 2: EMC application circuit with higher requirements

Component	Recommended value
FUSE	3.15A/300V, slow-blow, required
MOV	S14K350
R1	3Ω /3W (wire-wound resistor)

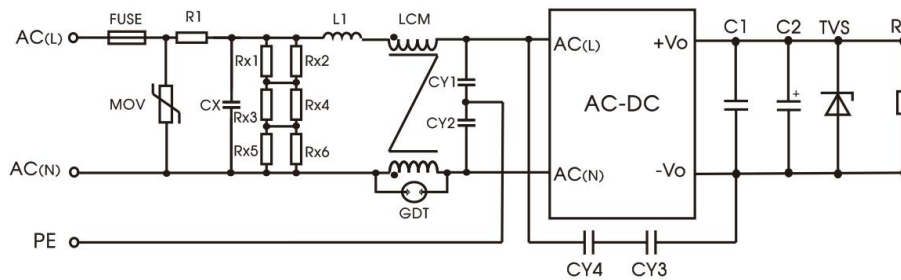

Fig 3: Recommended circuit for class I equipment

Component	Recommended value
FUSE	3.15A/300V, slow-blow, required
MOV	S14K350
CX	334K/305VAC
R1	6.8Ω /5W (wire-wound resistor)
L1	1.2mH/0.5A
CY1/CY2	2.2nF/400VAC
CY3/CY4	1nF/400VAC
GDT	300V/1KA
LCM	20 mH, we recommended using part no. FL2D-10-203 (MORNSUN)

Note: Rx1/Rx2/Rx3/Rx4/Rx5/Rx6 is the bleeder resistance of CX, and the recommended resistance value is 1.5MΩ /150VDC.

3. For additional information please refer to application notes on www.mornsun-power.com.

Dimensions and Recommended Layout

THIRD ANGLE PROJECTION

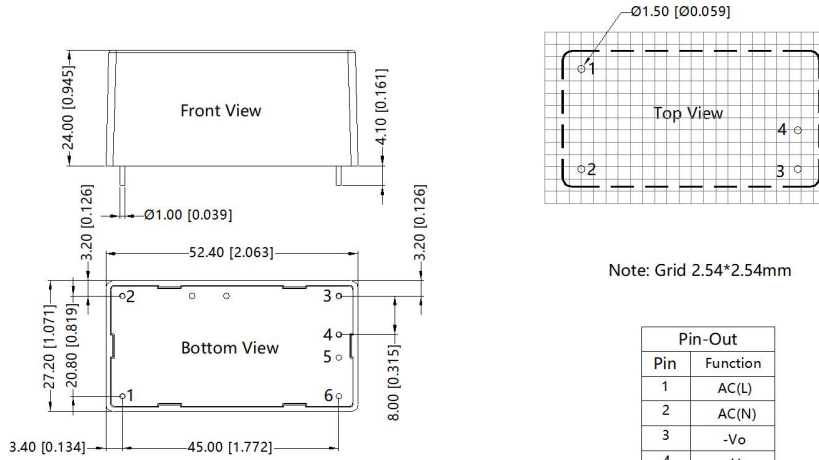

Note: Grid 2.54*2.54mm

Pin-Out	
Pin	Function
1	AC(L)
2	AC(N)
3	-Vo
4	+Vo
5	No Pin
6	No Pin

Note:
Unit: mm[inch]
Pin diameter tolerances: $\pm 0.10[\pm 0.004]$
General tolerances: $\pm 0.50[\pm 0.020]$

A2S Dimensions

THIRD ANGLE PROJECTION

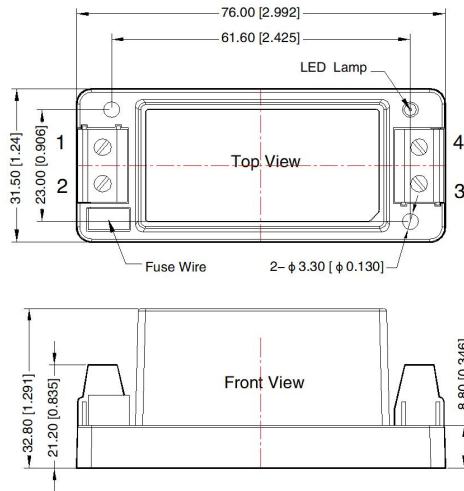

Pin-Out	
Pin	Function
1	AC(N)
2	AC(L)
3	-Vo
4	+Vo

Note:
Unit: mm[inch]
Wire range: 24-12 AWG
Tightening torque: Max 0.4 N·m
General tolerances: $\pm 1.00[\pm 0.039]$

A4S Dimensions

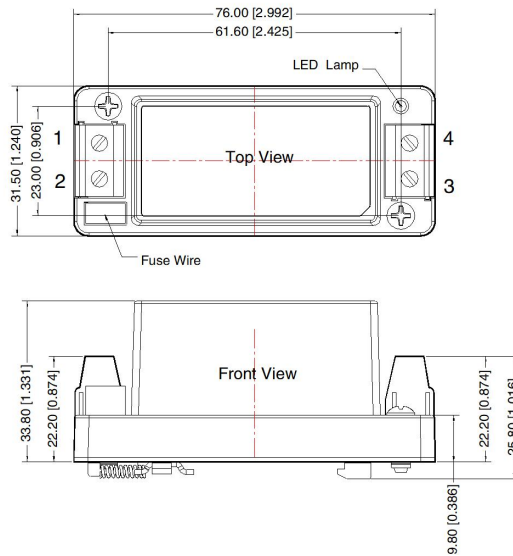

THIRD ANGLE PROJECTION

Pin-Out	
Pin	Function
1	AC(N)
2	AC(L)
3	-Vo
4	+Vo

Note:
Unit: mm[inch]
Wire range: 24-12 AWG
Tightening torque: Max 0.4 N·m
Mounting rail: TS35, rail needs to connect safety ground
General tolerances: ± 1.00 [± 0.039]

Note:

1. For additional information on Product Packaging please refer to www.mornsun-power.com. Packaging bag number: 58220011 (DIP package); 58220022 (A2S/A4S package);
2. If the product is not operated within the required load range, the product performance cannot be guaranteed to comply with all parameters in the datasheet;
3. Unless otherwise specified, parameters in this datasheet were measured under the conditions of $T_a=25^\circ\text{C}$, humidity<75% with nominal input voltage and rated output load;
4. All index testing methods in this datasheet are based on our company corporate standards;
5. We can provide product customization service, please contact our technicians directly for specific information;
6. Products are related to laws and regulations: see "Features" and "EMC";
7. Our products shall be classified according to ISO14001 and related environmental laws and regulations, and shall be handled by qualified units.

Mornsun Guangzhou Science & Technology Co., Ltd.

Address: No. 5, Kehui St. 1, Kehui Development Center, Science Ave., Guangzhou Science City, Huangpu District, Guangzhou, P. R. China
Tel: 86-20-38601850 Fax: 86-20-38601272 E-mail: info@mornsun.cn www.mornsun-power.com