

20W isolated DC-DC converter in DIP package,
Wide input and regulated single output

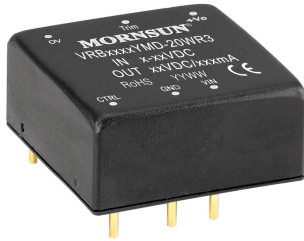

CE Patent Protection RoHS



FEATURES

- Wide 2:1 input voltage range
- High efficiency up to 91%
- I/O isolation test voltage 1.5k VDC
- Input under-voltage protection, output short circuit, over-current, over-voltage protection
- Operating ambient temperature range: -40°C to +105°C
- Industry standard pin-out
- EN62368 approved

VRB_YMD-20WR3 series of isolated DC-DC converter products feature a wide 2:1 input voltage with efficiency of up to 91%, 1500VDC input to output isolation, an operating ambient temperature range of -40°C to +105°C, input under-voltage protection, output over-voltage, over-current, short circuit protection, which makes them widely used in industrial control, electric power, instruments and communications applications.

Selection Guide

Certification	Part No.	Input Voltage (VDC)		Output		Full Load Efficiency ² (%) Min./Typ.	Max. Capacitive Load(μF)
		Nominal (Range)	Max. ^①	Voltage (VDC)	Current(mA) Max./Min.		
CE	VRB1203YMD-20WR3	12 (9-18)	20	3.3	5000/0	84/86	10000
	VRB1205YMD-20WR3			5	4000/0	87/89	10000
	VRB1212YMD-20WR3			12	1667/0	87/89	1600
	VRB1215YMD-20WR3			15	1333/0	88/90	1000
	VRB1224YMD-20WR3			24	833/0	88/90	500
	VRB2403YMD-20WR3	24 (18-36)	40	3.3	5000/0	86/88	10000
	VRB2405YMD-20WR3			5	4000/0	88/90	10000
	VRB2412YMD-20WR3			12	1667/0	88/90	1600
	VRB2415YMD-20WR3			15	1333/0	89/91	1000
	VRB2424YMD-20WR3			24	833/0	89/91	500
	VRB4803YMD-20WR3	48 (36-75)	80	3.3	5000/0	86/88	10000
	VRB4805YMD-20WR3			5	4000/0	88/90	10000
	VRB4812YMD-20WR3			12	1667/0	89/91	1600
	VRB4815YMD-20WR3			15	1333/0	89/91	1000
	VRB4824YMD-20WR3			24	833/0	89/91	500

Notes:

- ① Exceeding the maximum input voltage may cause permanent damage;
② Efficiency is measured at nominal input voltage and rated output load.

Input Specifications

Item	Operating Conditions	Min.	Typ.	Max.	Unit	
Input Current (full load / no-load)	12VDC nominal input series, nominal input voltage	3.3V output	--	1599/40	1637/70	mA
		5V output	--	1873/45	1916/70	
		12V output	--	1873/7	1916/20	
		15V output	--	1852/7	1894/20	
		24V output	--	1852/12	1894/20	
	24VDC nominal input series, nominal input voltage	3.3V output	--	782/30	800/50	
		5V output	--	926/35	947/55	
		12V output	--	926/6	947/15	
		15V output	--	916/6	937/15	
		24V output	--	916/10	937/20	

Input Current (full load / no-load)	48VDC nominal input series, nominal input voltage	3.3V output	--	391/15	400/30	mA
		5V output	--	463/20	474/30	
		12V output	--	458/3	469/15	
		15V output	--	458/3	469/15	
		24V output	--	458/4	469/15	
Reflected Ripple Current	Nominal input voltage	--	30	--		
Surge Voltage (1sec. max.)	12VDC nominal input series	-0.7	--	25	VDC	
	24VDC nominal input series	-0.7	--	50		
	48VDC nominal input series	-0.7	--	100		
Start-up Voltage	12VDC nominal input series	--	--	9	VDC	
	24VDC nominal input series	--	--	18		
	48VDC nominal input series	--	--	36		
Under-voltage Protection	12VDC nominal input series	5.5	6.5	--	VDC	
	24VDC nominal input series	12	15.5	--		
	48VDC nominal input series	26	30	--		
Start-up Time	Nominal input voltage & constant resistance load	--	10	--		ms
Input Filter		Pi filter				
Hot Plug		Unavailable				
Ctrl*	Module on	Ctrl pin open or pulled high (TTL 3.5-12VDC)				
	Module off	Ctrl pin pulled low to GND (0-1.2VDC)				
	Input current when off	--	2	7		mA

Note:*The Ctrl pin voltage is referenced to input GND.

Output Specifications

Item	Operating Conditions	Min.	Typ.	Max.	Unit
Voltage Accuracy	0%-100% load	--	±1	±3	%
Linear Regulation	Input voltage variation from low to high at full load	--	±0.2	±0.5	
Load Regulation	5%-100% load	--	±0.5	±1	
Transient Recovery Time		--	300	500	μs
Transient Response Deviation	25% load step change, nominal input voltage	3.3V, 5V output	±5	±8	%
		Others	±3	±5	
Temperature Coefficient	Full load	--	--	±0.03	%/°C
Ripple & Noise*	20MHz bandwidth, 5%-100% load	--	50	100	mV p-p
Trim	Input voltage range	90	--	110	%Vo
Over-voltage Protection		110	--	160	
Over-current Protection	Input voltage range	110	150	190	%Io
Short-circuit protection		Hiccup, continuous, self-recovery			

Note:
*Ripple & Noise at < 5% load is 5%Vo max. The "parallel cable" method is used for Ripple and Noise test, please refer to DC-DC Converter Application Notes for specific information.

General Specifications

Item	Operating Conditions	Min.	Typ.	Max.	Unit	
Isolation	Input-output Electric Strength Test for 1 minute with a leakage current of 1mA max.	1500	--	--	VDC	
	Input/output-case Electric Strength Test for 1 minute with a leakage current of 1mA max.	1000	--	--		
Insulation Resistance	Input-output resistance at 500VDC	1000	--	--	MΩ	
Isolation Capacitance	Input-output capacitance at 100KHz/0.1V	--	2000	--	pF	
Operating Temperature	See Fig. 1	3.3V, 5V output	-40	--	+95	°C
		Others	-40	--	+105	

Storage Temperature		-55	--	+125	°C	
Storage Humidity	Non-condensing	5	--	95	%RH	
Pin Soldering Resistance Temperature	Soldering spot is 1.5mm away from case for 10 seconds	--	--	+300	°C	
Vibration		10-150Hz, 5G, 0.75mm. along X, Y and Z				
Switching Frequency*	PWM mode	3.3V, 5V output	--	300	--	KHz
		Others	--	270	--	
MTBF	MIL-HDBK-217F@25°C	1000	--	--	K hours	
Note: *Switching frequency is measured at full load. The module reduces the switching frequency for light load (below 50%) efficiency improvement.						

Mechanical Specifications

Case Material	Aluminum alloy
Dimensions	25.40 × 25.40 × 11.70 mm
Weight	15.0g (Typ.)
Cooling method	Free air convection

Electromagnetic Compatibility (EMC)

Emissions	CE	CISPR32/EN55032	CLASS B (see Fig.3-② for recommended circuit)	
	RE	CISPR32/EN55032	CLASS B (see Fig.3-② for recommended circuit)	
Immunity	ESD	IEC/EN61000-4-2	Contact ±6KV, Air ±8KV	perf. Criteria B
	RS	IEC/EN61000-4-3	10V/m	perf. Criteria A
	EFT	IEC/EN61000-4-4	±2KV (see Fig.3-① for recommended circuit)	perf. Criteria A
	Surge	IEC/EN61000-4-5	line to line ±2KV (see Fig.3-① for recommended circuit)	perf. Criteria B
	CS	IEC/EN61000-4-6	3 Vr.m.s	perf. Criteria A

Typical Characteristic Curves

VRB12_YMD-20WR3 series
Nominal input voltage, 3.3V, 5V output

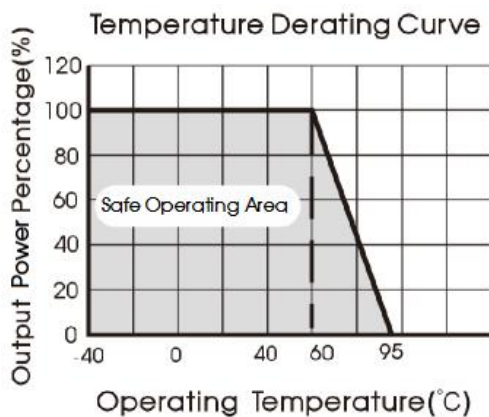

VRB12_YMD-20WR3 series
Nominal input voltage, 12V, 15V, 24V output

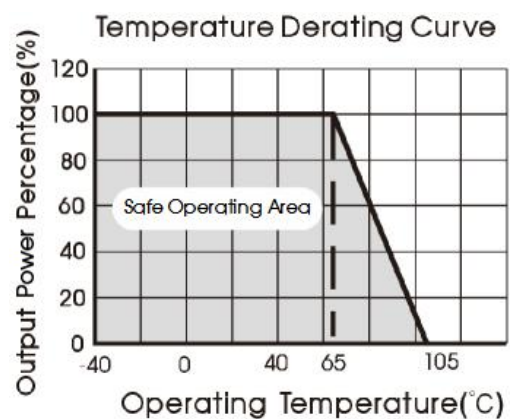

VRB24_YMD-20WR3/VRB48_YMD-20WR3 series
Nominal input voltage, 3.3V, 5V output

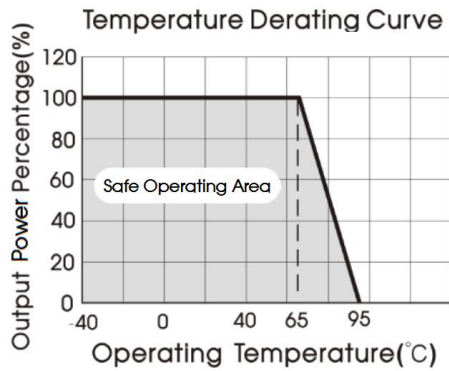

VRB24_YMD-20WR3/VRB48_YMD-20WR3 series
Nominal input voltage, 12V, 15V, 24V output

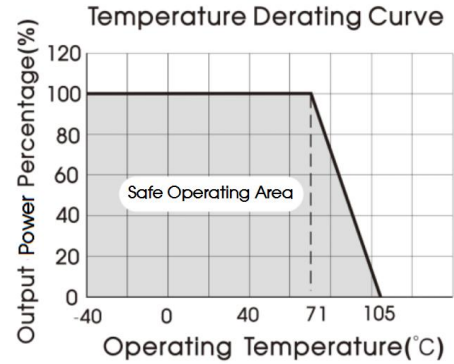
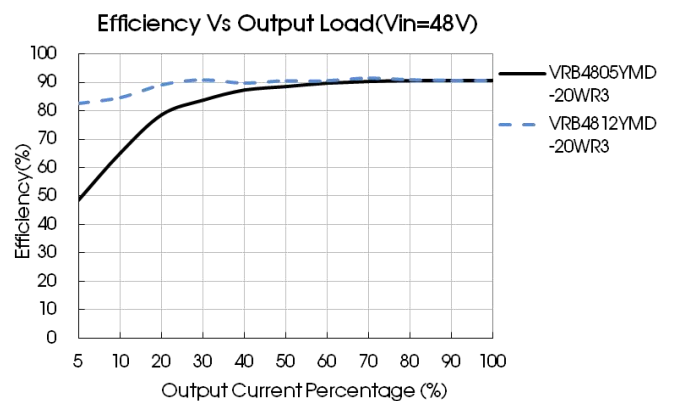
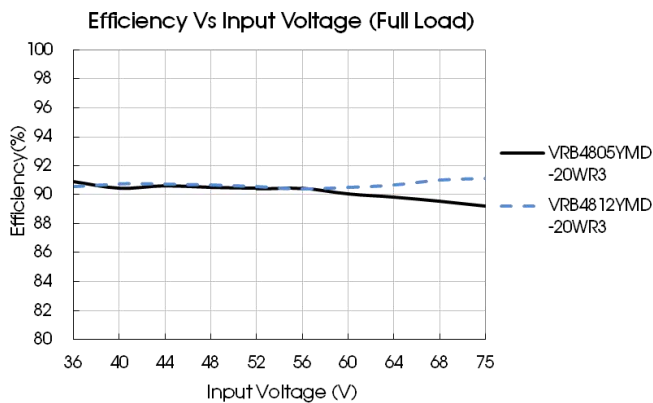
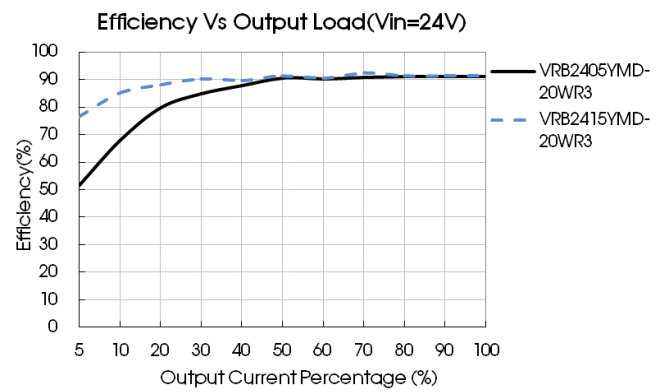
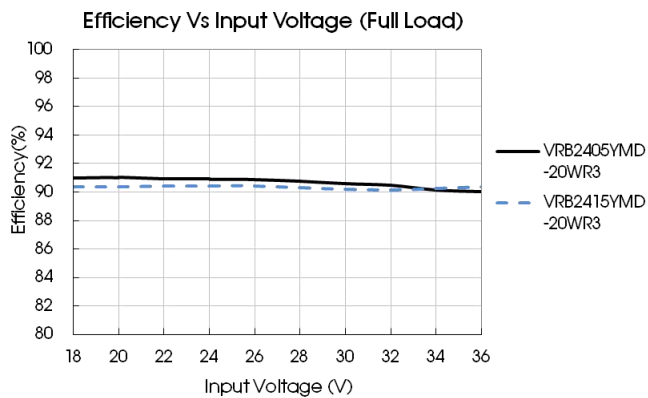
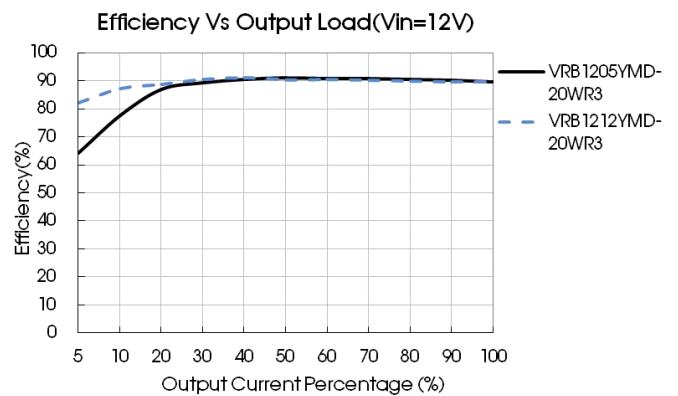
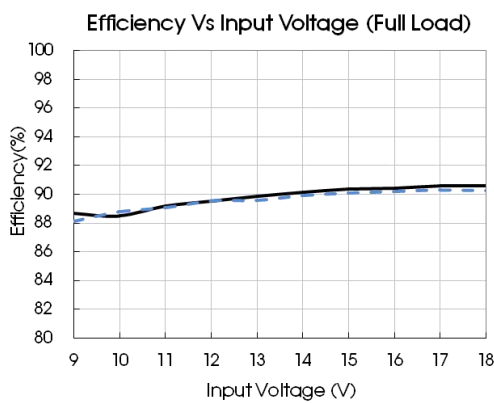

Fig. 1



Design Reference

1. Typical application

All DC-DC converters of this series are tested before delivery using the recommended circuit shown in Fig. 2.

Input and/or output ripple can be further reduced by appropriately increasing the input & output capacitor values C_{in} and C_{out} and/or by selecting capacitors with a low ESR (equivalent series resistance). Also make sure that the capacitance is not exceeding the specified max. capacitive load value of the product.



Fig. 2

Vout (VDC)	Cin (μF)	Cout (μF)
3.3/5/12/15	100	100
24		47

2. EMC compliance circuit

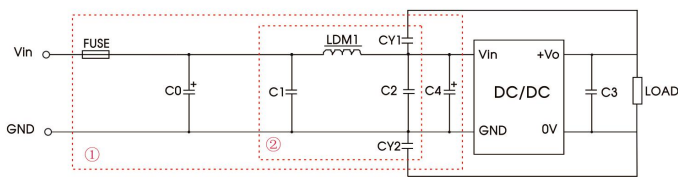

Fig. 3

Notes: For EMC tests we use Part ① in Fig. 3 for immunity and part ② for emissions test. Selecting based on needs.

Parameter description:

Model	Vin: 12V, 24V	Vin:48V
FUSE	Select fuse value according to actual input current	
C0, C4	330μF/50V	330μF/100V
C1, C2	4.7μF/50V	4.7μF/100V
C3	Refer to the Cout in Fig.2	
LDM1	2.2μH/4A	2.2μH/2A
CY1/CY2	1nF/2KV	

3. Trim Function for Output Voltage Adjustment (open if unused)

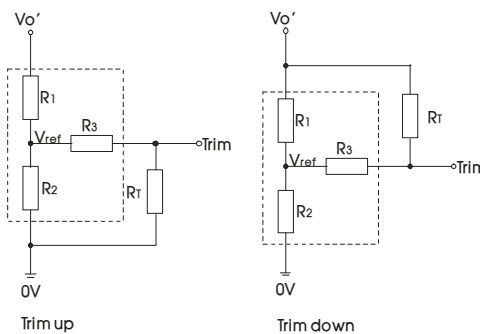

TRIM resistor connection (dashed line shows internal resistor network)

Calculating Trim resistor values:

$$\begin{aligned} \text{up: } R_T &= \frac{\alpha R_2}{R_2 - \alpha} - R_3 & \alpha &= \frac{V_{ref}}{V_o' - V_{ref}} \cdot R_1 \\ \text{down: } R_T &= \frac{\alpha R_1}{R_1 - \alpha} - R_3 & \alpha &= \frac{V_o' - V_{ref}}{V_{ref}} \cdot R_2 \end{aligned}$$

R_T = Trim Resistor value;
 α = self-defined parameter;
 V_o' = desired output voltage

Vout(V)	R1(KΩ)	R2(KΩ)	R3(KΩ)	Vref(V)
3.3	4.829	2.87	15	1.24
5	2.894	2.87	10	2.5
12	11.000	2.87	17.4	2.5
15	14.494	2.87	17.4	2.5
24	24.872	2.87	20	2.5

4. The products do not support parallel connection of their output

5. For additional information please refer to DC-DC converter application notes on www.mornsun-power.com

Dimensions and Recommended Layout

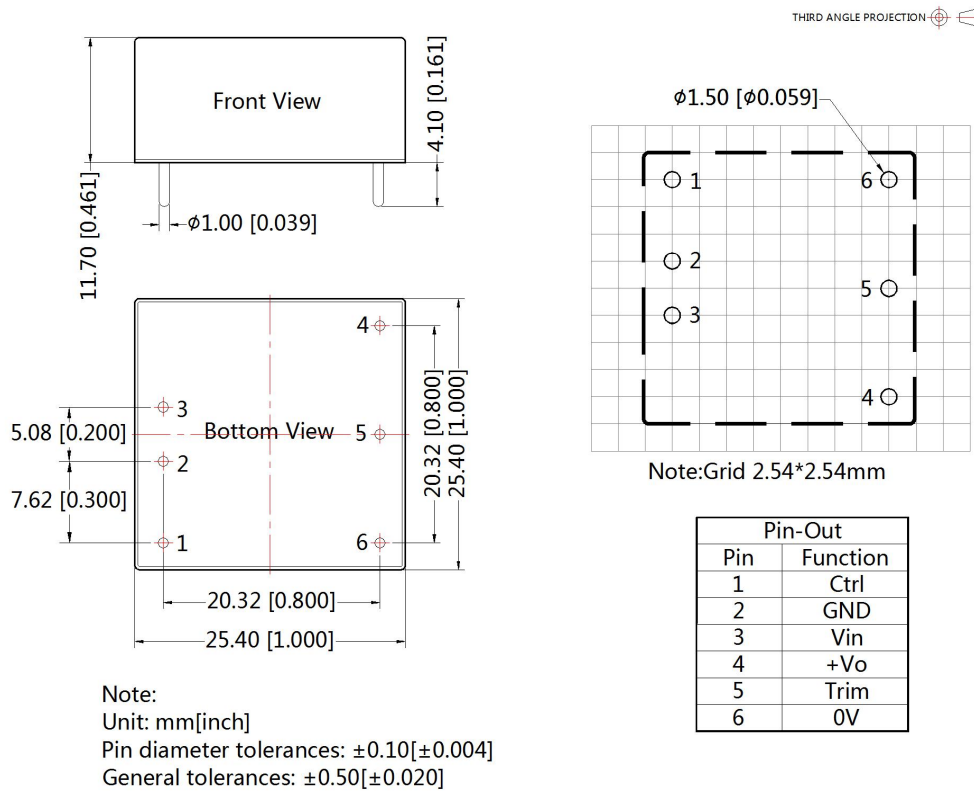

Note:

1. For additional information on Product Packaging please refer to www.mornsun-power.com. Packaging bag number: 58210003 (DIP) ;
2. The maximum capacitive load offered were tested at input voltage range and full load;
3. Unless otherwise specified, parameters in this datasheet were measured under the conditions of $T_a=25^{\circ}\text{C}$, humidity<75%RH with nominal input voltage and rated output load;
4. All index testing methods in this datasheet are based on company corporate standards;
5. We can provide product customization service, please contact our technicians directly for specific information;
6. Products are related to laws and regulations: see "Features" and "EMC";
7. Our products shall be classified according to ISO14001 and related environmental laws and regulations, and shall be handled by qualified units.

Mornsun Guangzhou Science & Technology Co., Ltd.

Address: No. 5, Kehui St. 1, Kehui Development Center, Science Ave., Guangzhou Science City, Huangpu District, Guangzhou, P. R. China
Tel: 86-20-38601850 Fax: 86-20-38601272 E-mail: info@mornsun.cn www.mornsun-power.com