

# GPS+WIFI Combination Antenna JCB003W

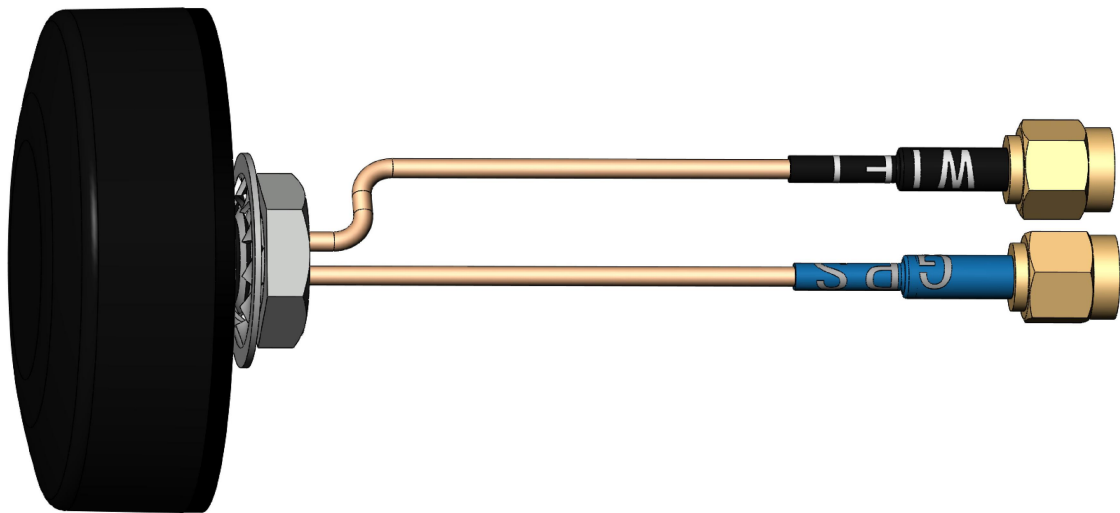

## DIMENSIONS

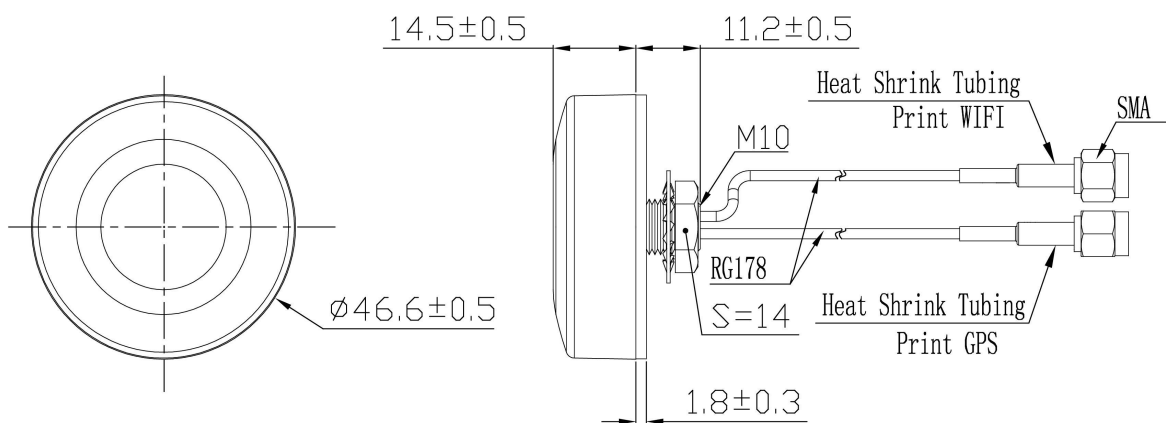

Unit:mm

**SPECIFICATIONS**

Item		Specifications	
GPS Antenna	Dielectric Antenna	Center Frequency	1575.42±3MHz
		Band Width	CF±4MHz
		Polarization	RHCP
		Gain	0dBic (Zenith)
		V.S.W.R	<1.5
		Impedance	50Ω
	LNA	Gain	20±2dB
		Noise Figure	<1.5dB
		V.S.W.R	<2.0
		Supply Voltage	3.3V DC
	Current Consumption	<10mA	
WIFI Antenna	Frequency Range	2400~2483.5/4800~5825MHz	
	V.S.W.R (min)	<2.5	
	Polarization	Linear	
	Gain	2dBi (Zenith)	
	Impedance	50Ω	
Mechanical	Cable	RG178	
	Connector	SMA or others	
	Radome Material	ABS	
	Mounting Method	Screw	
Environmental	Operating Temperature	-40℃~+85℃	
	Relative Humidity	Up to 95%	
	Ingress Protection	IP65~IP67 (exclude cable outlet)	
	Vibration	10 to 55Hz with 1.5mm amplitude 2hours	
	Environmentally Friendly	ROHS Compliant	

## Radiation Pattern

GPS Antenna

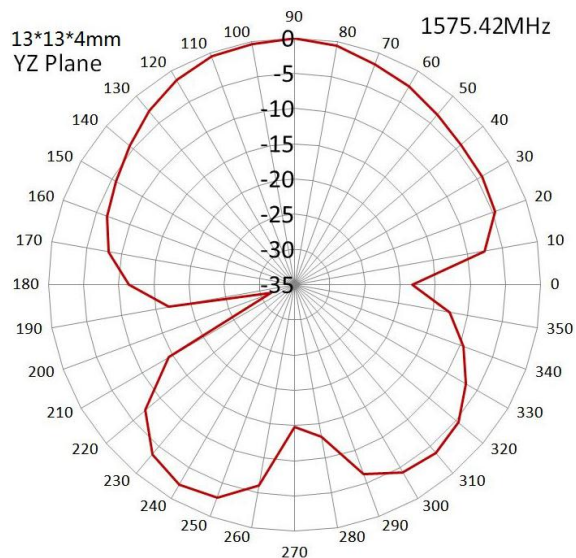
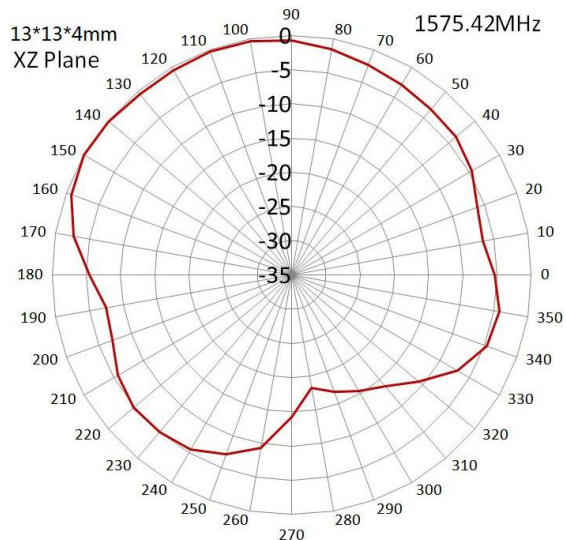
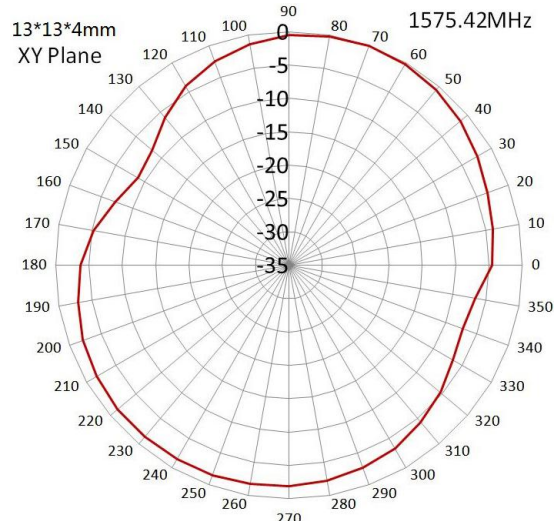

**JIAXING JINCHANG ELECTRONIC TECHNOLOGY CO.,LTD**

Add: 398#, Zhenye Road, South Street, Jiaxing, Zhejiang, China

Http:// [www.jinchanggps.com](http://www.jinchanggps.com)

E-mail: [jcgps@vip.163.com](mailto:jcgps@vip.163.com)

Tel: 86-0573-83692157/83692605/83958637 Fax: 86-0573-83958635



WIFI Antenna

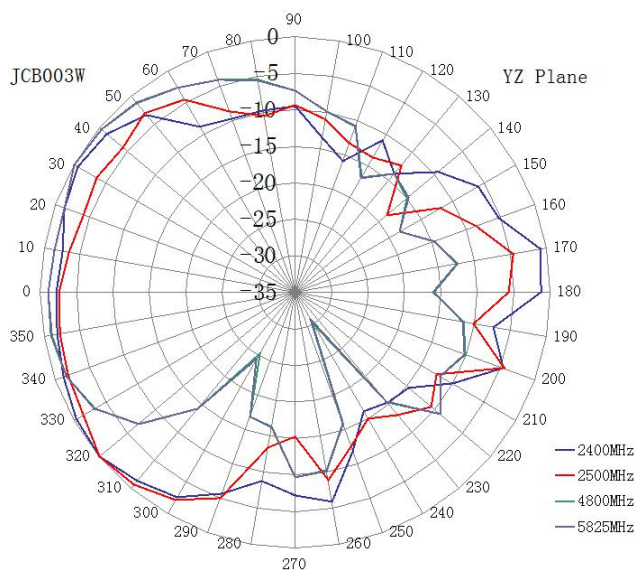
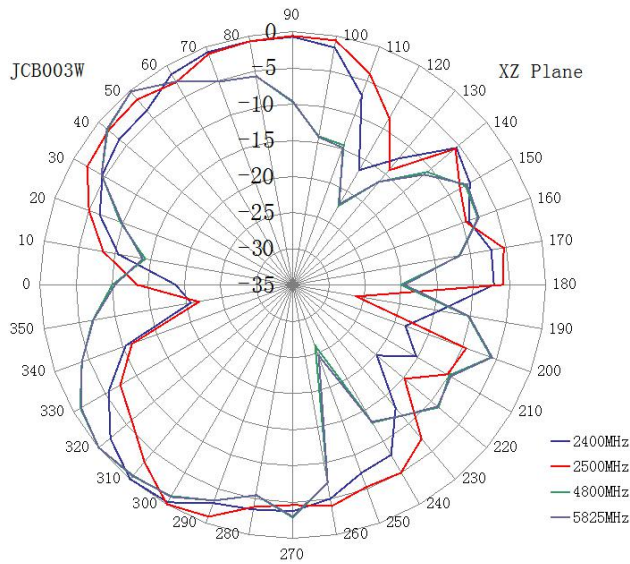
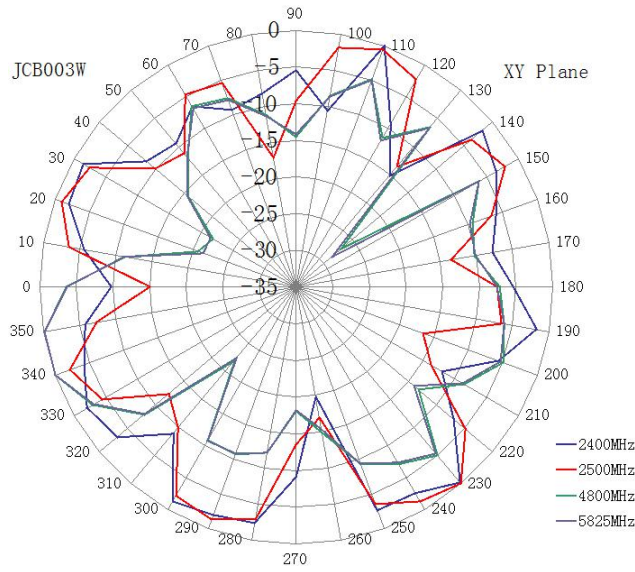

JIAXING JINCHANG ELECTRONIC TECHNOLOGY CO.,LTD

Add: 398#,Zhenye Road, South Street, Jiaxing, Zhejiang, China

Http:// www.jinchanggps.com

E-mail:jcgps@vip.163.com

Tel: 86-0573-83692157/83692605/83958637 Fax:86-0573-83958635