

1W isolated DC-DC converter
Fixed input voltage and regulated single output

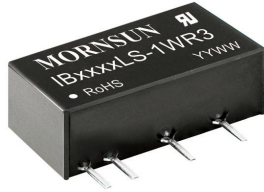

Continuous Short
Circuit Protection

UL US CE CB Patent Protection RoHS



FEATURES

- Continuous short-circuit protection
- No-load input current as low as 5mA
- Operating ambient temperature range: -40°C to +85°C
- High efficiency up to 73%
- I/O isolation test voltage 1.5k VDC
- Industry standard pin-out
- SIP package
- IEC62368, UL62368, EN62368 approved

IB05_LS-1WR3 series is especially designed for distributed power supply systems where an isolated voltage is required. They are suitable for occasions of : pre-interference isolation, ground interference elimination, pure digital circuit, voltage isolation conversion, general low frequency analog circuit, relay drive circuit, etc.

Selection Guide

Certification	Part No.	Input Voltage (VDC)	Output		Full Load Efficiency (%) Min./Typ.	Capacitive Load (µF) Max.
		Nominal (Range)	Voltage (VDC)	Current (mA) Max./Min.		
CE	IB0503LS-1WR3	5 (4.75-5.25)	3.3	250/25	63/67	2400
UL/CE/CB	IB0505LS-1WR3		5	200/20	66/70	2400
	IB0509LS-1WR3		9	111/12	67/71	1000
	IB0512LS-1WR3		12	84/9	68/72	560
	IB0515LS-1WR3		15	67/7	69/73	560
CE	IB0524LS-1WR3		24	41/4	69/73	100

Input Specifications

Item	Operating Conditions	Min.	Typ.	Max.	Unit
Input Current (full load / no-load)	3.3VDC/5VDC output	--	286/5	303/10	mA
	9VDC/12VDC output	--	282/12	299/20	
	15VDC/24VDC output	--	274/18	290/30	
Reflected Ripple Current*		--	15	--	
Input Filter		Capacitance Filter			
Hot Plug		Unavailable			

Note: * Refer to DC-DC Converter Application Notes for detailed description of reflected ripple current test method.

Output Specifications

Item	Operating Conditions	Min.	Typ.	Max.	Unit	
Voltage Accuracy		--	--	±3	%	
Linear Regulation	Input voltage change: ±1%	--	--	±0.25	%	
Load Regulation	10%-100% load	3.3VDC output	--	--	±3	%
		Others	--	--	±2	
Ripple & Noise*	20MHz bandwidth	Others	--	30	75	mVp-p
		24V output	--	50	100	
Temperature Coefficient	100% load	--	±0.02	--	%/°C	
Short-circuit Protection		Continuous, self-recovery				

Note: * The "parallel cable" method is used for Ripple and Noise test, please refer to DC-DC Converter Application Notes for specific information.

General Specifications

Item	Operating Conditions	Min.	Typ.	Max.	Unit	
Isolation	Input-output Electric Strength Test for 1 minute with a leakage current of 1mA max.	1500	--	--	VDC	
Insulation Resistance	Input-output resistance at 500VDC	1000	--	--	MΩ	
Isolation Capacitance	Input-output capacitance at 100kHz/0.1V	--	20	--	pF	
Operating Temperature	Derating when operating temperature $\geq 71^{\circ}\text{C}$ (see Fig.1)	-40	--	85	°C	
Storage Temperature		-55	--	125		
Case Temperature Rise	Ta=25°C	3.3VDC output		--		30
		Others		--		25
Pin Soldering Resistance Temperature	Soldering spot is 1.5mm away from case for 10 seconds	--	--	300		
Storage Humidity	Non-condensing	--	--	95	%RH	
Vibration		10-150Hz, 5G, 30 Min. along X, Y and Z				
Switching Frequency	100% load, nominal input voltage	--	270	--	KHz	
MTBF	MIL-HDBK-217F@25°C	3500	--	--	K hours	

Mechanical Specifications

Case Material	Black plastic; flame-retardant and heat-resistant (UL94 V-0)
Dimensions	19.65 x 6.0 x 10.16mm
Weight	2.1g(Typ.)
Cooling Method	Free air convection

Electromagnetic Compatibility (EMC)

Emissions	CE	CISPR32/EN55032	CLASS B (see Fig. 3 for recommended circuit)
	RE	CISPR32/EN55032	CLASS B (see Fig. 3 for recommended circuit)
Immunity	ESD	IEC/EN61000-4-2	Air $\pm 8\text{kV}$, Contact $\pm 4\text{kV}$ perf. Criteria B

Typical Characteristic Curves

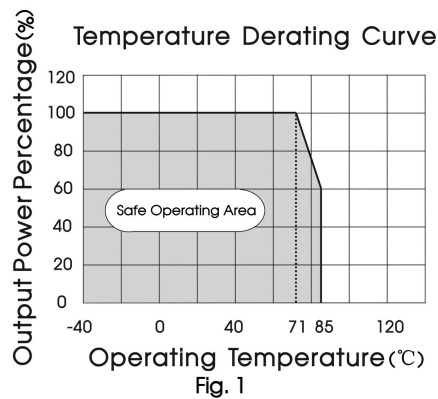

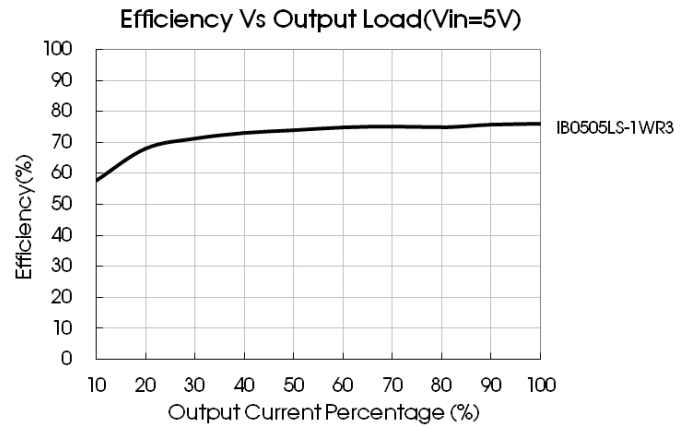
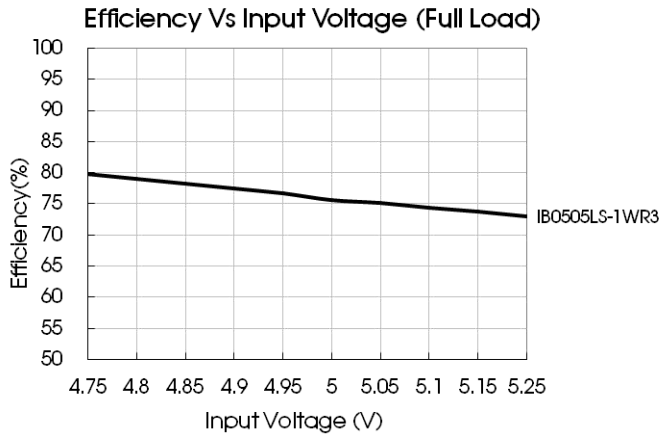

Design Reference

1. Typical application circuit

Input and/or output ripple can be further reduced, by connecting a filter capacitor from the input and/or output terminals to ground as shown in Fig.2.

Choosing suitable filter capacitor values is very important for a smooth operation of the modules, particularly to avoid start-up problems caused by capacitor values that are too high. For recommended input and output capacitor values refer to Table 1.

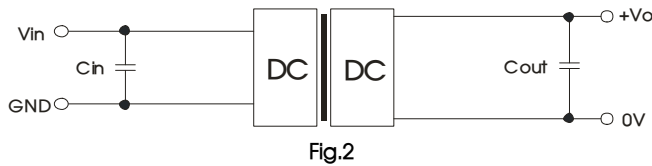

Table 1: Recommended input and output capacitor values

Vin(VDC)	Cin(μF)	Vo (VDC)	Cout(μF)
5	4.7	3.3/5	10
--	--	9/12	2.2
--	--	15	1

2. EMC compliance circuit

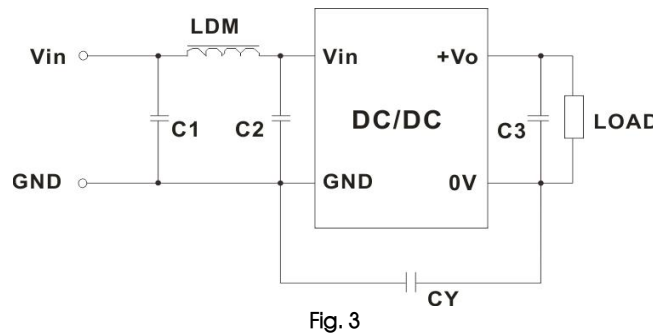

Table 2: Recommended EMC filter values

Input voltage 5VDC	Output voltage (VDC)		3.3/5/9	12/15/24
	Emissions	C1/C2	4.7μF /25V	4.7μF /25V
CY		--	--	VISHAY HGZ102MBP TDK CD45-E2GA102M-GKA
C3		Refer to the Cout in table 1		
LDM		6.8μH	6.8μH	6.8μH

Note: We recommend the use of a Y-capacitor CY with a value of 1nF/4kV to help even further reduce Emissions.

3. For additional information please refer to DC-DC converter application notes on

www.mornsun-power.com.

Dimensions and Recommended Layout

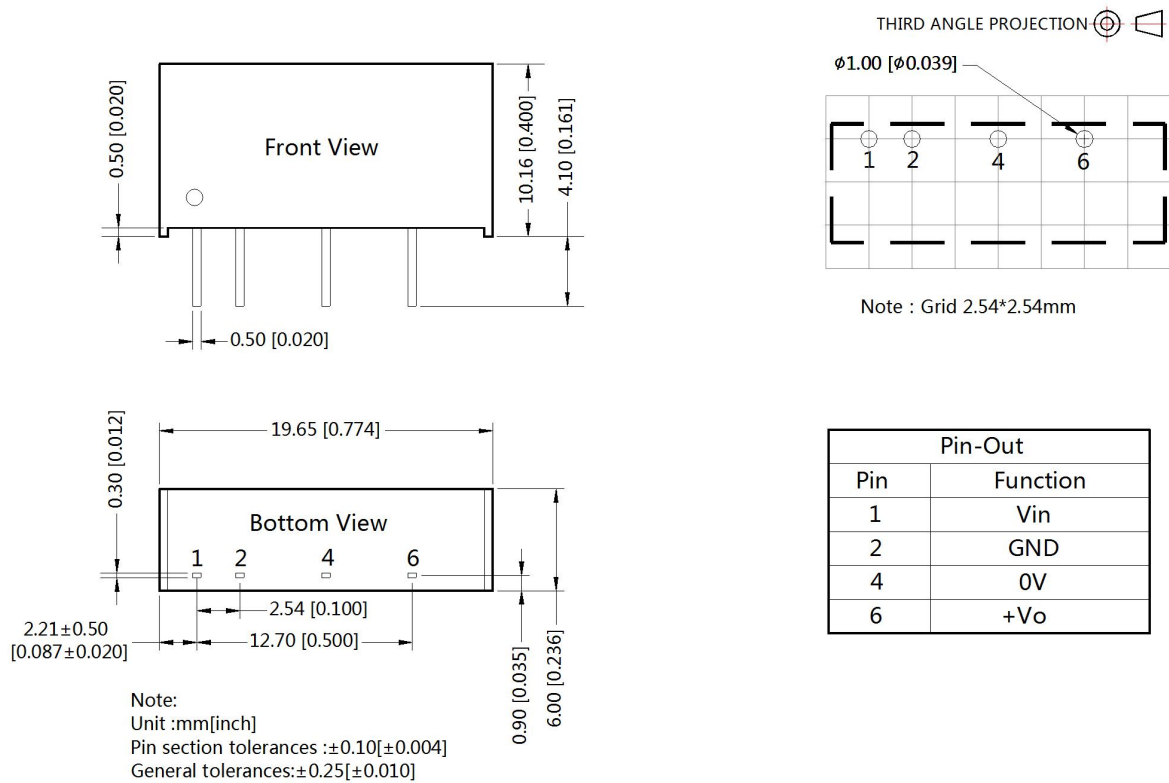

Notes:

1. For additional information on Product Packaging please refer to www.mornsun-power.com. Packaging bag number: 58200001;
2. If the product is not operated within the required load range, the product performance cannot be guaranteed to comply with all parameters in the datasheet;
3. The maximum capacitive load offered were tested at input voltage range and full load;
4. Unless otherwise specified, parameters in this datasheet were measured under the conditions of T_a=25°C, humidity<75%RH with nominal input voltage and rated output load;
5. All index testing methods in this datasheet are based on our company corporate standards;
6. We can provide product customization service, please contact our technicians directly for specific information;
7. Products are related to laws and regulations: see "Features" and "EMC";
8. Our products shall be classified according to ISO14001 and related environmental laws and regulations, and shall be handled by qualified units.

MORNSUN Guangzhou Science & Technology Co., Ltd.

Address: No. 5, Kehui St. 1, Kehui Development Center, Science Ave., Guangzhou Science City, Huangpu District, Guangzhou, P. R. China
Tel: 86-20-38601850 Fax: 86-20-38601272 E-mail: info@mornsun.cn www.mornsun-power.com