

ODU AMC[®] REAR PANEL MOUNT RECEPTACLE, SIZE 0, IP6K8 / IP6K9K, 7 CONTACTS, A (LIGHT BROWN) KEY



- **Part number** GK0YAR-P07WCD0-000L
- **Type of connector** Rear panel mount receptacle
- **Number of contacts** 7
- **Keying** A (light brown)
- **Cable diameter** 3 - 5.5 mm



DIMENSIONS:

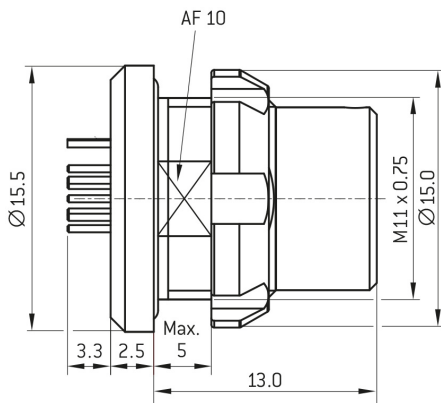

POSITIONS: 7 Positions

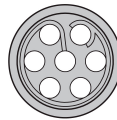

CODING: A



PANEL CUT OUT:



Contact Insert Description

Number of contacts	7
Contact type	Sockets
Contact diameter	0.5 mm
Insulator material	PEEK
Wire cross section	26 AWG
Termination type	Solder
Termination diameter	0.65 mm
Reverse gender on request	

ODU AMC[®] REAR PANEL MOUNT RECEPTACLE, SIZE 0, IP6K8 / IP6K9K, 7 CONTACTS, A (LIGHT BROWN) KEY



Technical information

Nominal current single contact	5.0 A	IEC 60512-5-2:2002 (DIN EN 60512-5-2:2003)
Test voltage	0.9 kV DC	EIA-364-20F:2019-02

All shown connectors are rated to a safety extra low voltage (SELV) of less than 50 V AC / 75 V DC, according to IEC 61140:2016 (VDE 0140-1:2016) Protection against electric shock - Common aspects for installation and equipment. In case other standards rule a specific use of the connector, the application specific safety criteria shall be considered first. In this context, lower voltage ratings may be valid. Warning: Danger to life for operating voltages above 50 V AC / 120 V DC!

Mechanical and Environmental data

Degree of protection*	IP6K8 / IP6K9K
Operating temperature	-51°C - 125°C
Mating cycles	5000
*mated condition	

Material and Surface Treatments

Housing	Aluminum with ruthenium finish
Contact	Cu-alloy with gold finish

General information

All shown connectors are defined without breaking capacity (COC) according to IEC 61984:2008 (VDE 0627:2009).

The respective selected ODU connectors with data transfer functionality can transmit common data transmission such as HDMI[®] 2.0, USB[®] 3.2 Gen 1x1, FireWire[®] and eSATA[®], but they are not HDMI[®]-, USB[®]-, FireWire[®]- and eSATA[®]-standard connectors.

ODU reserves the right to make changes based on the current state of knowledge without prior notice without being obliged to provide replacement deliveries or refinements of older designs.