

ODU MINI-SNAP® SERIES K FRONT PANEL MOUNT RECEPTACLE, SIZE 1, IP68, 14 CONTACTS, 0° KEY



- **Part number** G11K0C-P14LCC0-0000
- **Type of connector** Front panel mount receptacle
- **Size** 1
- **Number of contacts** 14
- **Keying** 0°



DIMENSIONS

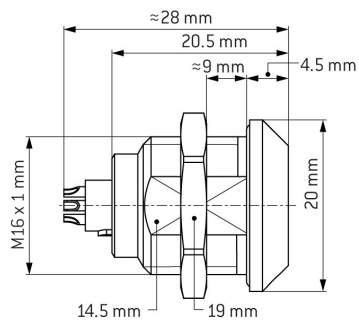

POSITIONS: 14 Positions



CODING: 0°



PANEL CUT OUT:



Contact Insert Description

Number of contacts	14
Contact type	Sockets
Contact diameter	0.5 mm
Insulator material	PEEK
Wire cross section	28 AWG
Termination type	Solder
Termination diameter	0.4 mm
Reverse gender on request	

ODU MINI-SNAP[®] SERIES K FRONT PANEL MOUNT RECEPTACLE, SIZE 1, IP68, 14 CONTACTS, 0° KEY



Technical information

Max. creepage and air clearance distance	0.5 mm (Contact to contact)	0.5 mm (Contact to housing)
Nominal current single contact	4.0 A	IEC 60512-5-2:2002 (DIN EN 60512-5-2:2003)
Nominal current insert (per individual contact)	2.0 A	VDE 0298-4:2003
Test voltage	0.9 kV DC	SAE AS 13441:1998 method 3001.1

All shown connectors are rated to a safety extra low voltage (SELV) of less than 50 V AC / 75 V DC, according to IEC 61140:2016 (VDE 0140-1:2016) Protection against electric shock - Common aspects for installation and equipment. In case other standards rule a specific use of the connector, the application specific safety criteria shall be considered first. In this context, lower voltage ratings may be valid. Warning: Danger to life for operating voltages above 50 V AC / 120 V DC!

Mechanical and Environmental data

Degree of protection*	IP68
Operating temperature	-40°C - 120°C
Mating cycles	5000
*mated condition	

Material and Surface Treatments

Housing	Cu-alloy with matt chrome finish
Contact	Cu-alloy with gold finish

General information

All shown connectors are defined without breaking capacity (COC) according to IEC 61984:2008 (VDE 0627:2009).

The respective selected ODU connectors with data transfer functionality can transmit common data transmission such as HDMI[®] 2.0, USB[®] 3.2 Gen 1x1, FireWire[®] and eSATA[®], but they are not HDMI[®]-, USB[®]-, FireWire[®]- and eSATA[®]-standard connectors.

ODU MEDI-SNAP[®] and MINI-SNAP[®] is UL-approved (E110586).

ODU reserves the right to make changes based on the current state of knowledge without prior notice without being obliged to provide replacement deliveries or refinements of older designs.