

GSM+WIFI Combination Antenna JCG058W

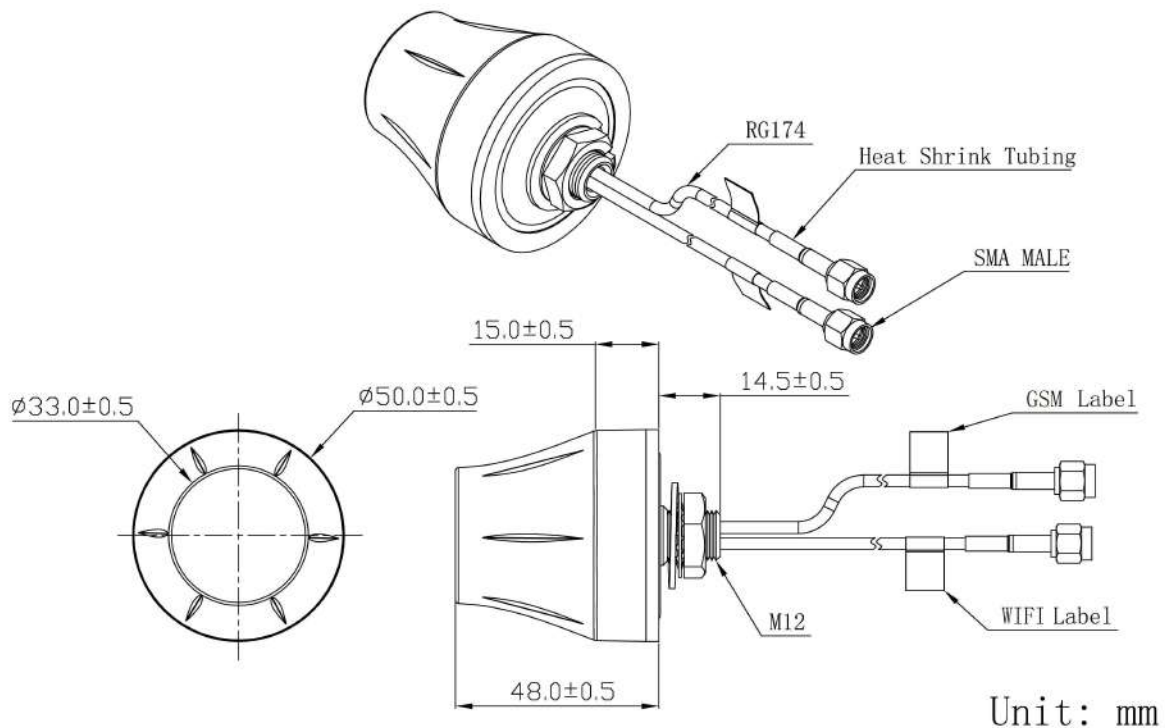

DIMENSIONS



Unit: mm



SPECIFICATIONS

Item		Specifications
GSM Antenna	Frequency Range	824~960MHz/1710~2170MHz
	V.S.W.R	<2.0
	Polarization	Linear
	Gain	2.0dBi
	Impedance	50Ω
WIFI Antenna	Frequency Range	2400~2483.5MHz
	Band Width	83.5MHz
	Polarization	Linear
	Gain	3dBi
	V.S.W.R	<2.0
	Impedance	50 Ω
Mechanical	Cable	RG174
	Connector	SMA/MCX/FAKRA or others
	Material	ABS
	Mounting Method	Screw
Environmental	Operating Temperature	-40°C~+85°C
	Relative Humidity	Up to 95%
	Ingress Protection	IP67 (exclude cable outlet)
	Vibration	10 to 55Hz with 1.5mm amplitude 2hours
	Environmentally Friendly	ROHS Compliant

Radiation Pattern

GSM Antenna

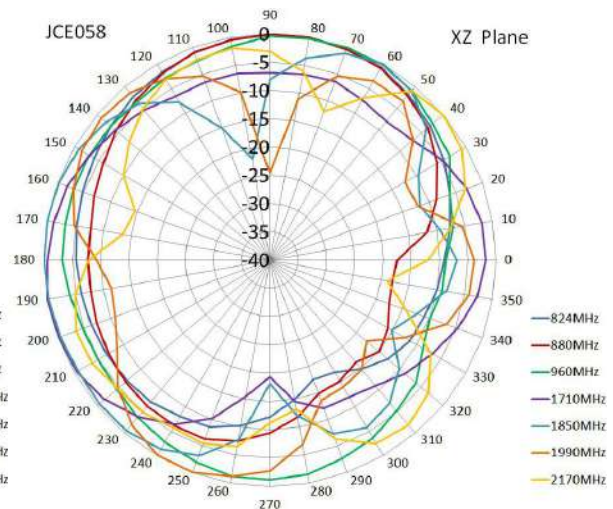
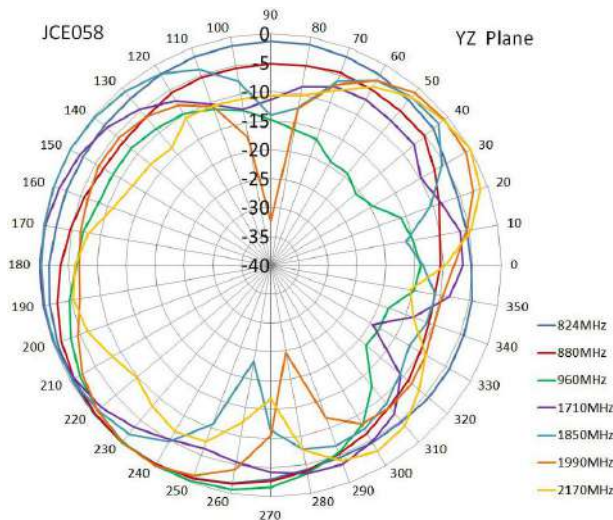
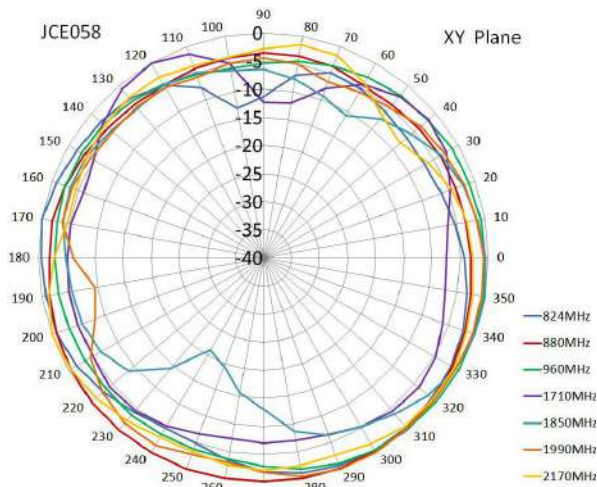

WIFI Antenna

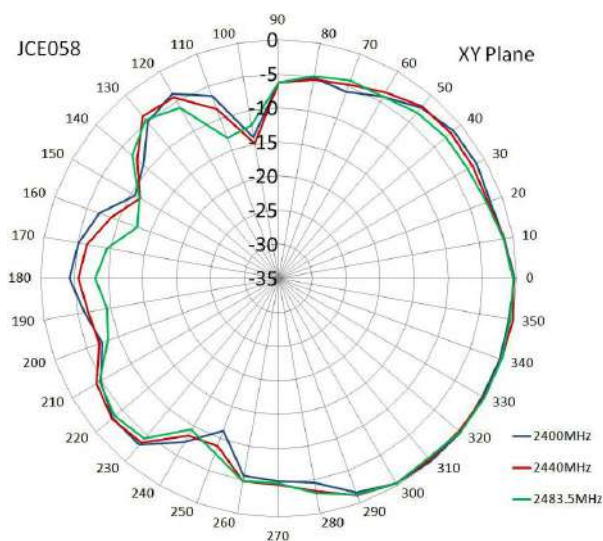



Jinchang Electron Global Service

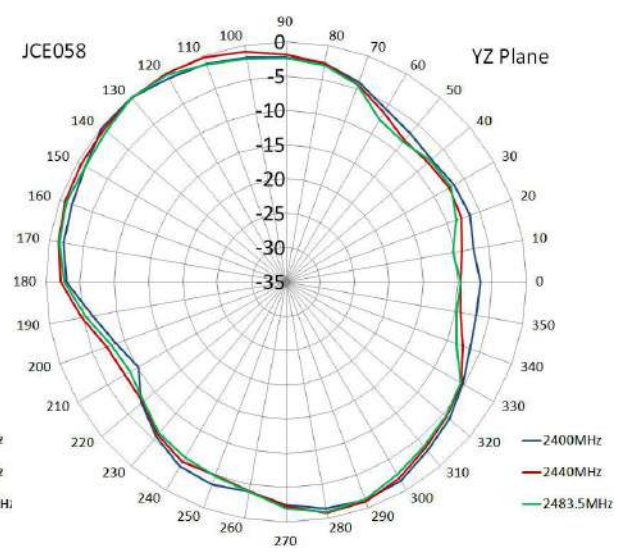
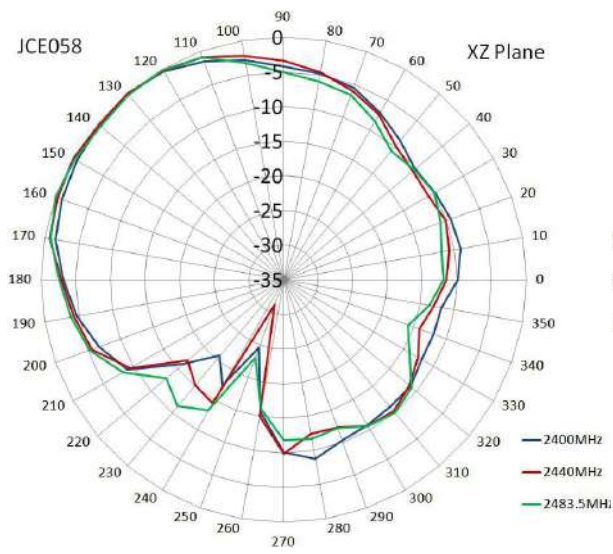

Zhejiang JC Antenna Co., Ltd.
Address: 398#, Zhenye Road, South Street, Jiaxing, Zhejiang, China
www.jinchanggps.com

Contact: Dora Soong
Email&Skype: sale2@jinchanggps.com
Mobile: +86 18405863271