

1W isolated DC-DC converter
Fixed input voltage, unregulated quad output

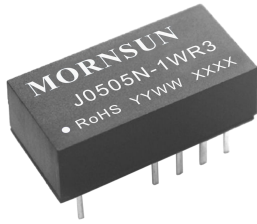

Continuous Short Circuit Protection



Patent Protection RoHS

FEATURES

- Continuous short-circuit protection
- Operating temperature range: -40°C to +105°C
- High efficiency up to 85%
- Isolation: Input-output 1500VDC Output-output 1000VDC
- Compact DIP package
- Meets UL62368, EN62368

J0505N-1WR3 is specifically designed for applications that require four independent sets of power supplies that are isolated from the input power supply. These products apply to:

- 1) Where the voltage of the input power supply is fixed (voltage variation $\leq \pm 10\%$);
 - 2) Where isolation is necessary between input and output (isolation voltage $\leq 1500\text{VDC}$);
- Such as: purely digital circuits, ordinary low frequency analog circuits, and multi-channel isolated power supply circuits.

Selection Guide

Certification	Part No.	Input Voltage(VDC)	Output								Full Load Efficiency(%) Min./Typ.	Capacitive Load(μF) Max.*
		Nominal (Range)	Voltage (VDC)				Current(mA) Max./Min.					
--	J0505N-1WR3	5 (4.5-5.5)	Vo1	Vo2	Vo3	Vo4	Io1	Io2	Io3	Io4	76/85	680
			5	5	5	5	50/5	50/5	50/5	50/5		

Note: *Each of the four outputs has the same maximum capacitive load.

Input Specifications

Item	Operating Conditions	Min.	Typ.	Max.	Unit
Current (full load / no-load)	5VDC input	--	250/20	263/40	mA
Reflected Ripple Current*		--	15	--	
Surge Voltage (1sec. max.)	5VDC input	-0.7	--	9	VDC
Input Filter		Capacitance filter			
Hot Plug		Unavailable			

Note: * Refer to DC-DC Converter Application notes for detailed description of reflected ripple current test method.

Output Specifications

Item	Operating Conditions	Min.	Typ.	Max.	Unit
Voltage Accuracy		See output regulation curve(Fig. 1)			
Linear Regulation	Input voltage change: $\pm 1\%$	--	--	± 1.2	%/%
Load Regulation	10%-100% load	--	--	15	%
Ripple & Noise*	20MHz bandwidth	--	50	75	mVp-p
Temperature Coefficient	100% load	--	± 0.03	--	%/°C
Short-circuit Protection		Continuous, self-recovery			

Note: *The "parallel cable" method is used for ripple and noise test, please refer to DC-DC Converter Application Notes for specific information.

General Specifications

Item	Operating Conditions	Min.	Typ.	Max.	Unit
Isolation	Input-output electric strength test for 1 minute with a leakage current of 1mA max.	1500	--	--	VDC
	Output-output electric strength test for 1 minute with a leakage current of 1mA max.	1000	--	--	

Insulation Resistance	Input-output resistance at 500VDC	1000	--	--	MΩ
Isolation Capacitance	Input-output capacitance at 100kHz/0.1V	--	40	--	pF
Operating Temperature	Derating when operating temperature ≥ 85°C, (see Fig. 2)	-40	--	105	°C
Storage Temperature		-55	--	125	
Case Temperature Rise	Ta=25°C	--	15	--	
Pin Soldering Resistance Temperature	Soldering spot is 1.5mm away from case for 10 seconds	--	--	300	
Storage Humidity	Non-condensing	--	--	95	%RH
Switching Frequency	100% load, nominal input voltage	--	270	--	KHz
MTBF	MIL-HDBK-217F@25°C	3500	--	--	K hours

Mechanical Specifications

Case Material	Black plastic; flame-retardant and heat-resistant (UL94 V-0)
Dimensions	20.32 x 10.16 x 8.20mm
Weight	3.0g(Typ.)
Cooling Method	Free air convection

Electromagnetic Compatibility (EMC)

Emissions	CE	CISPR32/EN55032 CLASS B (see Fig. 4 for recommended circuit)
	RE	CISPR32/EN55032 CLASS B (see Fig. 4 for recommended circuit)
Immunity	ESD	IEC/EN61000-4-2 Contact ±4kV, perf. Criteria C

Typical Characteristic Curves

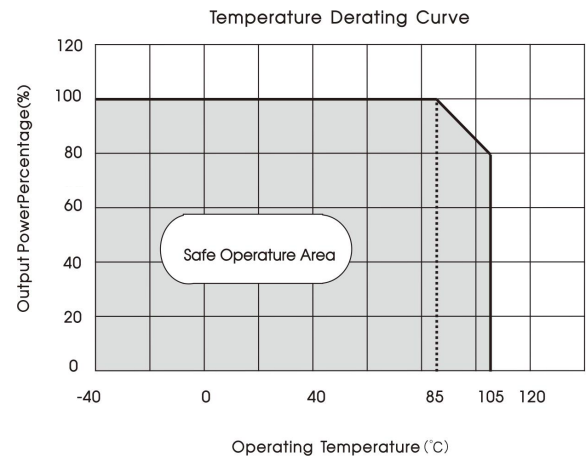
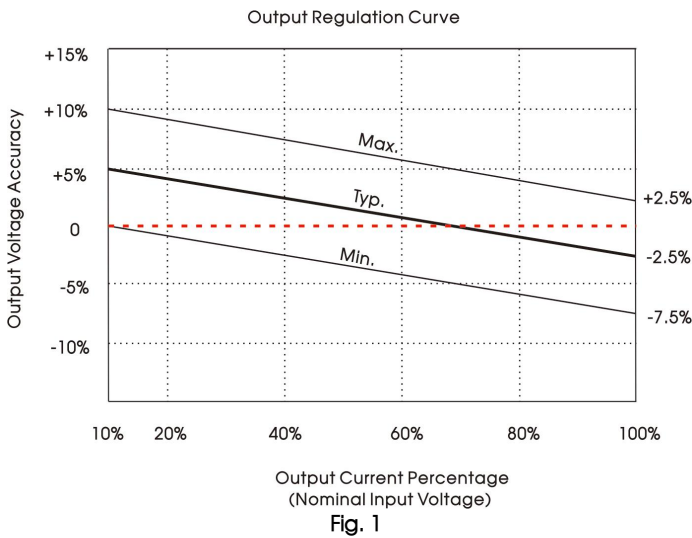
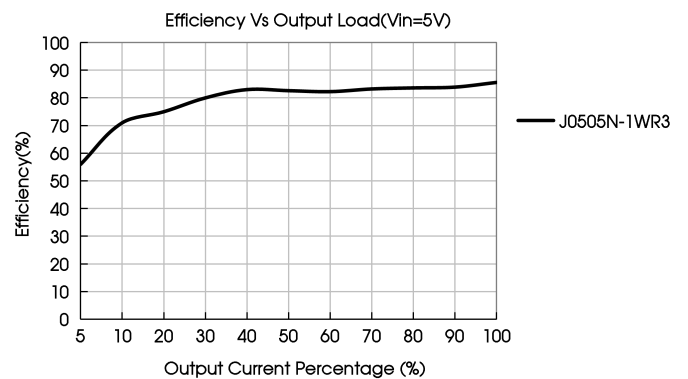
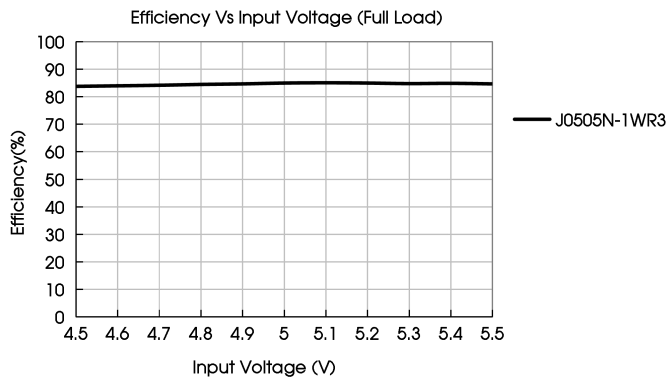

Fig. 2



Design Reference

1. Typical application

Input and/or output ripple can be further reduced, by connecting a filter capacitor from the input and/or output terminals to ground as shown in Fig.3.

Choosing suitable filter capacitor values is very important for a smooth operation of the modules, particularly to avoid start-up problems caused by capacitor values that are too high. For recommended input and output capacitor values refer to Table 1.

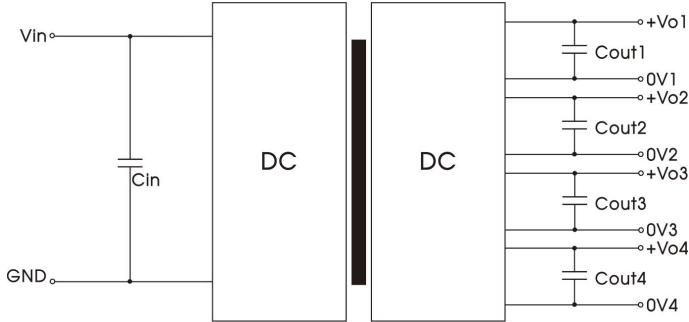

Fig.3

Recommended capacitive load value table (Table 1)

Vin (VDC)	Cin	Vout (VDC)	Cout
5	4.7μF/10V	5	10μF/10V

2. EMC (CLASS B) compliance circuit

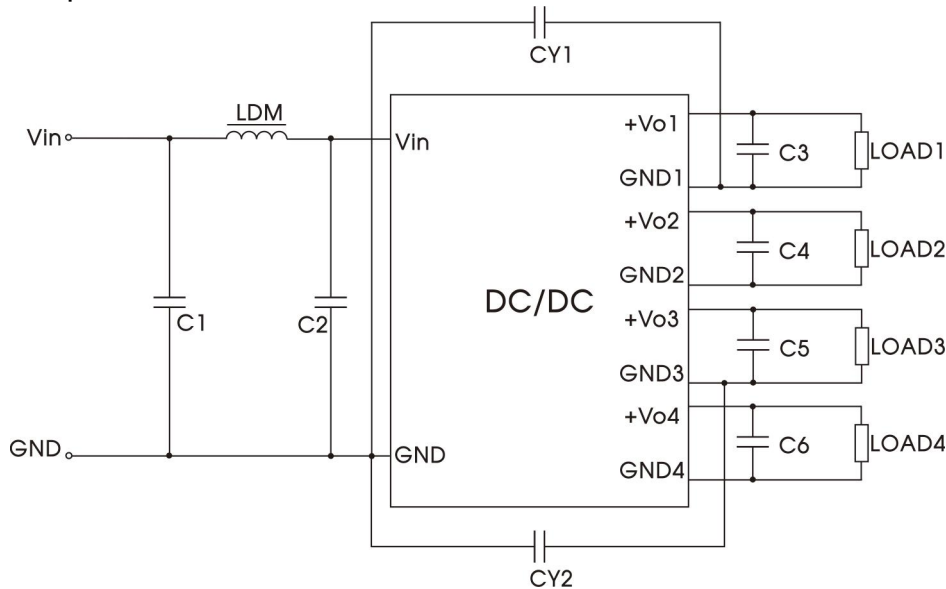

Fig.4

EMC recommended circuit value table (Table 2)

Input voltage 5VDC	Output voltage (VDC)	
	EMI	5
	C1/C2	4.7μF /25V
	CY1/CY2	47pF/2000V
	C3/C4/C5/C6	10μF/25V
	LDM	6.8μH

Note: In the case of actual use, the requirements for EMI are high, it is subject to CY .

3. For additional information please refer to DC-DC converter application notes on

www.mornsun-power.com

Dimensions and Recommended Layout

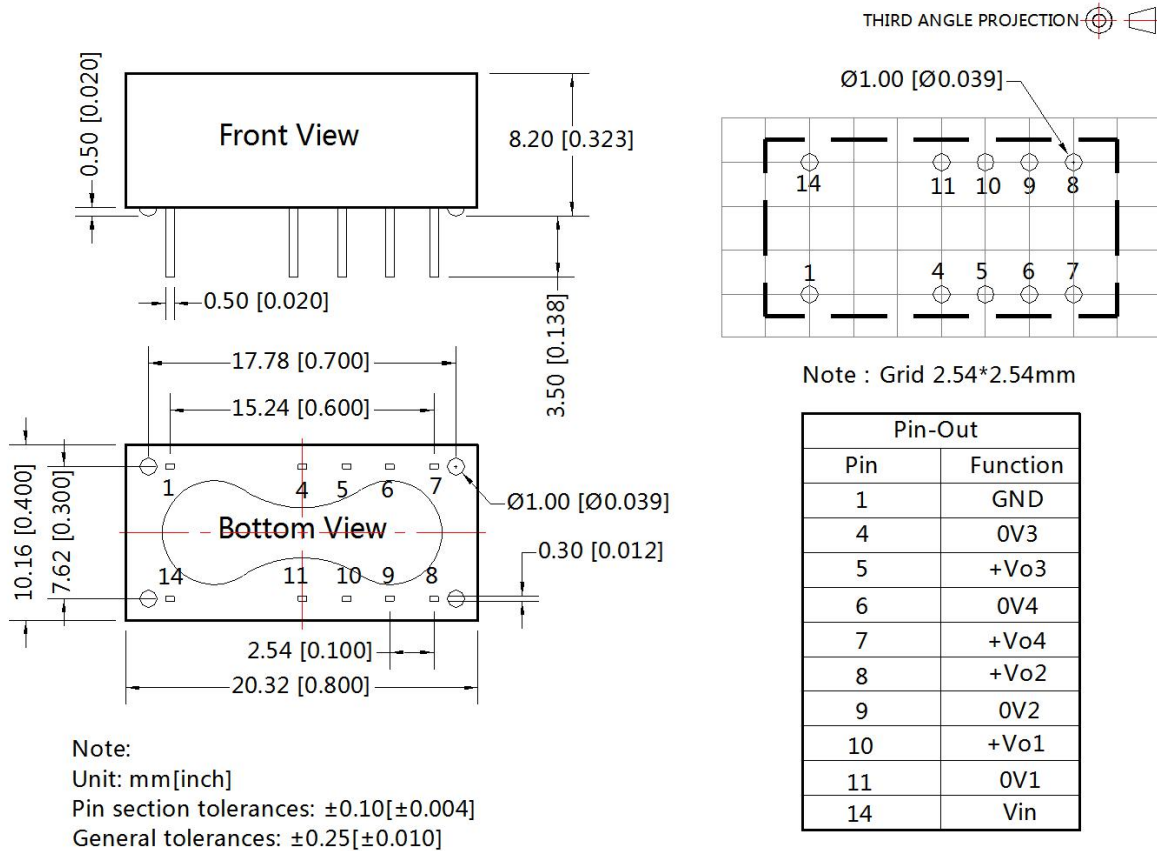

Notes:

1. Packaging information please refer to Product Packing Information which can be downloaded from www.mornsun-power.com.
Packaging bag number: 58200009;
2. If the product is not operated within the required load range, the product performance cannot be guaranteed to comply with all parameters in the datasheet;
3. The maximum capacitive load offered were tested at input voltage range and full load;
4. Unless otherwise specified, parameters in this datasheet were measured under the conditions of $T_a=25^\circ\text{C}$, humidity<75%RH with nominal input voltage and rated output load;
5. All index testing methods in this datasheet are based on our company corporate standards;
6. We can provide product customization service, please contact our technicians directly for specific information;
7. Products are related to laws and regulations: see "Features" and "EMC";
8. Our products shall be classified according to ISO14001 and related environmental laws and regulations, and shall be handled by qualified units.

MORNSUN Guangzhou Science & Technology Co., Ltd.

Address: No. 5, Kehui St. 1, Kehui Development Center, Science Ave., Guangzhou Science City, Luogang District, Guangzhou, P. R. China
Tel: 86-20-38601850-8801 Fax: 86-20-38601272 E-mail: info@mornsun.cn