

# GPS/BD+FM+WIFI Combination Antenna JCM070

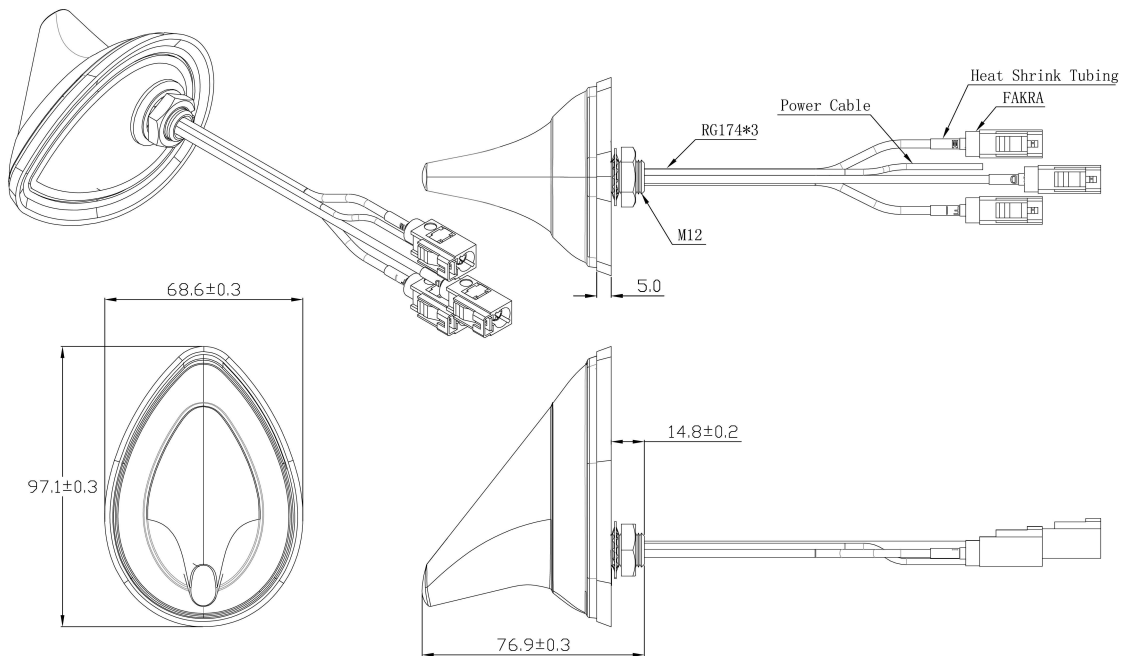

## DIMENSIONS



Unit: mm

## SPECIFICATIONS

JIAXING JINCHANG ELECTRONIC TECHNOLOGY CO.,LTD  
Add: 398#, Zhenye Road, South Street, Jiaxing, Zhejiang, China  
Http:// www.jinchanggps.com E-mail: jcgps@vip.163.com  
Tel: 86-0573-83692157/83692605/83958637 Fax: 86-0573-83958635



Item		Specifications	
GPS&BD Antenna	Dielectric Antenna	Center Frequency	1568±3MHz
		Polarization	RHCP
		Gain	2dBic (Zenith)
		V.S.W.R	<1.5
		Impedance	50Ω
		Axial Ratio	3dB (max)
	LNA	Gain	28±2dB
		Noise Figure	<1.5
		Ex-band Attenuation	12dB@CF+50MHz/16dB@CF-50MHz
		V.S.W.R	<2.0
		Supply Voltage	2.2~5V DC
Current Consumption	5~15mA		
WIFI Antenna		Frequency Range	2400~2483.5MHz
		V.S.W.R	<2.5
		Polarization	Linear
		Gain	2dBi
		Impedance	50Ω
FM/AM Antenna		Frequency Range	520~1629KHz/76~108MHz
		V.S.W.R	<2.5
		Polarization	Linear
		Gain	20/12dBi
		Impedance	50Ω
		Supply Voltage	12V DC
Environmental		Operating Temperature	-40℃~+85℃
		Relative Humidity	Up to 95%
		Ingress Protection	IP65~IP67 (exclude cable outlet)
		Vibration	10 to 55Hz with 1.5mm amplitude 2hours
		Environmentally Friendly	ROHS Compliant

**Radiation Pattern**

GPS Antenna

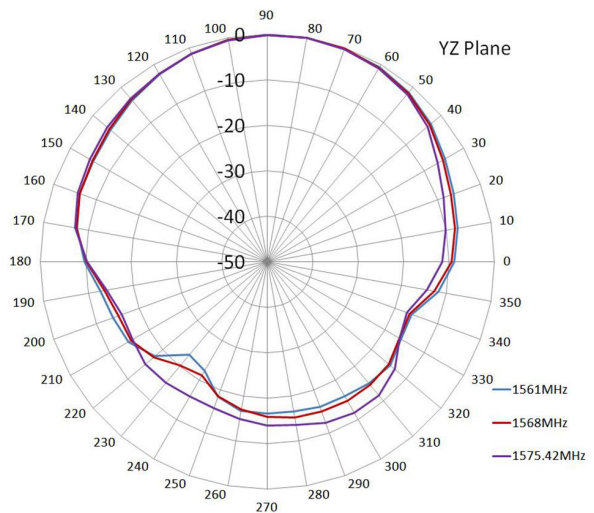
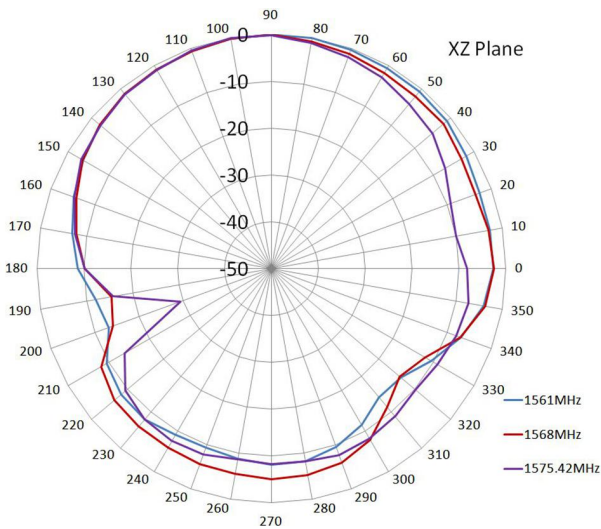
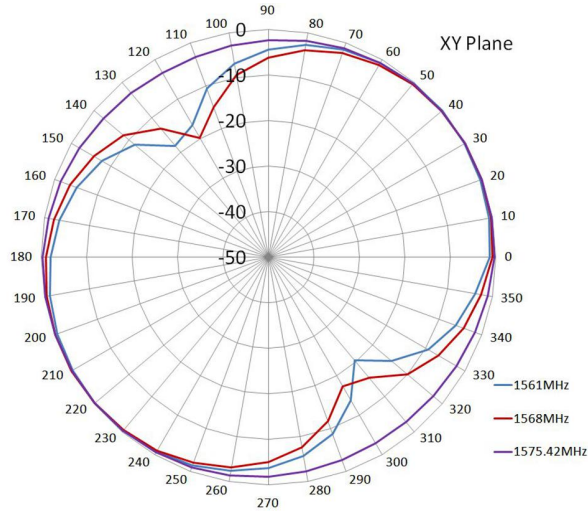

WIFI Antenna

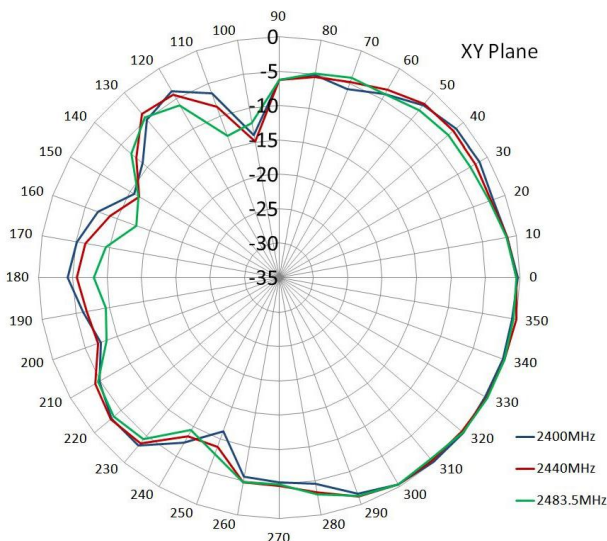



Jinchang Electron Global Service

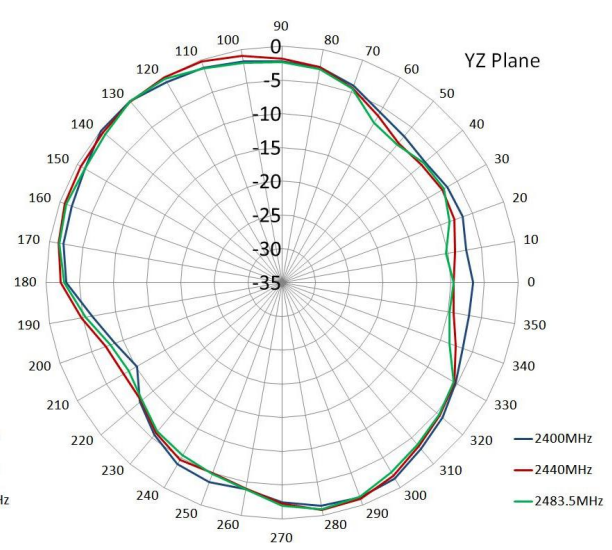
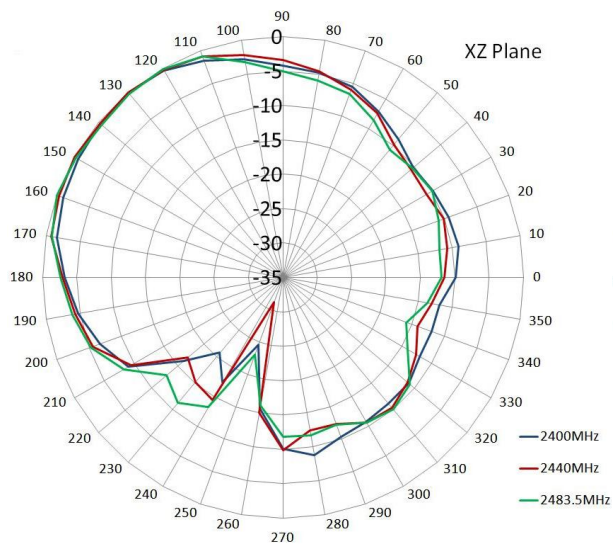

**JIAXING JINCHANG ELECTRONIC TECHNOLOGY CO.,LTD**

Address: 398#, Zhenye Road, South Street, Jiaxing, Zhejiang, China

Http:// [www.jinchanggps.com](http://www.jinchanggps.com)

E-mail: [jcgps@vip.163.com](mailto:jcgps@vip.163.com)

Tel: 86-0573-83692157/83692605/83958637 Fax: 86-0573-83958635