

关键参数	Key Parameters		
$V_{CES}$		1700	V
$V_{CE(sat)}$	(typ)	1.75	V
$I_C$	(max)	2400	A
$I_{C(RM)}$	(max)	4800	A

典型应用	Typical Applications
● 牵引传动	Traction drives
● 电机控制	Motor Controllers
● 智能电网	Smart Grid
● 高可靠性逆变器	High Reliability Inverter

特点	Features
● AISiC基板	AISiC Base
● AIN衬板	AIN Substrates
● 高热循环能力	High Thermal Cycling Capability
● 10 $\mu$ s短路承受能力	10 $\mu$ s Short Circuit Withstand
● 低 $V_{ce(sat)}$ 型器件	Low $V_{ce(sat)}$ device
● 高电流密度	High current density

**电路结构 Circuit Configuration**

 图1. 电路结构  
 Fig. 1 Circuit configuration

 图2. 模块外形  
 Fig. 2 Module appearance

**模块标签说明**

**ab1234567890**
**Module Label code**

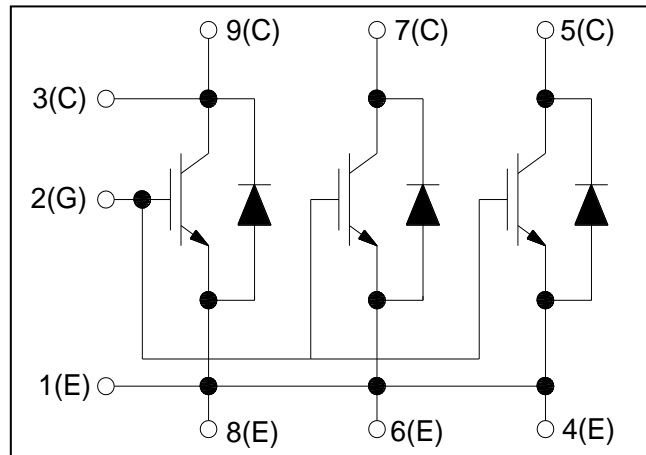
数据位置	数据内容
Data position	Content of data
1--8	模块批次号 Module batch number
9--12	模块序列号 Module serial number

**TIM2400ESM17-TSA000**
**额定值**

 除非特别声明，否则  $T_{case} = 25\text{ }^{\circ}\text{C}$ 
**Absolute Maximum Rating**
 $T_{case} = 25\text{ }^{\circ}\text{C}$  unless stated otherwise

符号 (Symbol)	参数名称 (Parameter)	测试条件 (Test Conditions)	数值 (value)	单位 (Unit)
$V_{CES}$	集电极-发射极电压 Collector-emitter voltage	$V_{GE} = 0V, T_{vj} = 25\text{ }^{\circ}\text{C}$	1700	V
$V_{GES}$	栅极-发射极电压 Gate-emitter voltage		$\pm 20$	V
$I_C$	集电极电流 Collector-emitter current	$T_{case} = 100\text{ }^{\circ}\text{C}, T_{vj} = 150\text{ }^{\circ}\text{C}$	2400	A
$I_{C(PK)}$	集电极峰值电流 Peak collector current	$t_p = 1ms$	4800	A
$P_{max}$	晶体管部分最大损耗 Max. transistor power dissipation	$T_{vj} = 150\text{ }^{\circ}\text{C}, T_{case} = 25\text{ }^{\circ}\text{C}$	19.2	kW
$I^2t$	二极管 $I^2t$ 值 Diode $I^2t$	$V_R = 0V, t_p = 10ms, T_{vj} = 150\text{ }^{\circ}\text{C}$	1170	$\text{kA}^2\text{s}$
$V_{isol}$	绝缘电压(模块) Isolation voltage – per module	短接所有端子，端子与基板间施加电压 (Commoned terminals to base plate), AC RMS, 1 min, 50Hz	4000	V
$Q_{PD}$	局部放电电荷(模块) Partial discharge – per module	IEC1287. V1 = 1800V, V2 = 1300V, 50Hz RMS	10	pC

**热和机械数据**
**Thermal & Mechanical Data**

爬电距离	Creepage distance	33mm
绝缘间隙	Clearance	20mm
耐漏电起痕指数	CTI (Critical Tracking Index)	>600

符号 (Symbol)	参数名称 (Parameter)	测试条件 (Test Conditions)	最小 (Min)	最大 (Max)	单位 (Unit)
$R_{th(J-C) IGBT}$	IGBT结壳热阻 Thermal resistance – IGBT	结壳恒定功耗 Continuous dissipation - junction to case		6.5	K / kW
$R_{th(J-C) Diode}$	二极管结壳热阻 Thermal resistance – diode	结壳恒定功耗 Continuous dissipation - junction to case		13	K / kW
$R_{th(C-H)}$	接触热阻(模块) Thermal resistance – case to heatsink (per module)	安装力矩5Nm (导热脂 $1W/m\cdot^{\circ}\text{C}$ ) Mounting torque 5Nm (with mounting grease $1W/m\cdot^{\circ}\text{C}$ )		6	K / kW
$T_{vj}$	结温 Junction temperature	IGBT部分 (IGBT)		150	$^{\circ}\text{C}$
		二极管部分 (Diode)		150	$^{\circ}\text{C}$
$T_{stg}$	存储温度 Storage temperature range		-40	150	$^{\circ}\text{C}$
$M$	安装力矩 Screw torque	安装紧固用 - M6 Mounting - M6		5	Nm
		电路互连用 - M4 Electrical connections - M4		2	Nm
		电路互连用 - M8 Electrical connections - M8		10	Nm

**电特性值**
**Electrical Characteristics**

 除非特别声明，否则  $T_{case} = 25\text{ }^{\circ}\text{C}$ 
 $T_{case} = 25\text{ }^{\circ}\text{C}$  unless stated otherwise

符号 (Symbol)	参数名称 (Parameter)	条件 (Test Conditions)	最小 (Min)	典型 (Typ)	最大 (Max)	单位 (Unit)
$I_{CES}$	集电极截止电流 Collector cut-off current	$V_{GE} = 0V, V_{CE} = V_{CES}$			1	mA
		$V_{GE} = 0V, V_{CE} = V_{CES}, T_{case} = 125\text{ }^{\circ}\text{C}$			40	mA
		$V_{GE} = 0V, V_{CE} = V_{CES}, T_{case} = 150\text{ }^{\circ}\text{C}$			60	mA
$I_{GES}$	栅极漏电流 Gate leakage current	$V_{GE} = \pm 20V, V_{CE} = 0V$			1	$\mu\text{A}$
$V_{GE(TH)}$	栅极-发射极阈值电压 Gate threshold voltage	$I_C = 80\text{mA}, V_{GE} = V_{CE}$	5.0	6.0	7.0	V
$V_{CE(sat)}^{(*1)}$	集电极-发射极饱和电压 Collector-emitter saturation voltage	$V_{GE} = 15V, I_C = 2400A$		1.75		V
		$V_{GE} = 15V, I_C = 2400A, T_{vj} = 125\text{ }^{\circ}\text{C}$		1.95		V
		$V_{GE} = 15V, I_C = 2400A, T_{vj} = 150\text{ }^{\circ}\text{C}$		2.05		V
$I_F$	二极管正向直流电流 Diode forward current	DC		2400		A
$I_{FRM}$	二极管正向重复峰值电流 Diode maximum forward current	$t_P = 1\text{ms}$		4800		A
$V_F^{(*1)}$	二极管正向电压 Diode forward voltage	$I_F = 2400A$		1.65		V
		$I_F = 2400A, T_{vj} = 125\text{ }^{\circ}\text{C}$		1.75		V
		$I_F = 2400A, T_{vj} = 150\text{ }^{\circ}\text{C}$		1.75		V
$C_{ies}$	输入电容 Input capacitance	$V_{CE} = 25V, V_{GE} = 0V, f = 1\text{MHz}$		400		nF
$Q_g$	栅极电荷 Gate charge	$\pm 15V$		19		$\mu\text{C}$
$C_{res}$	反向传输电容 Reverse transfer capacitance	$V_{CE} = 25V, V_{GE} = 0V, f = 1\text{MHz}$		3		nF
$L_M$	模块电感 Module inductance			10		nH
$R_{INT}$	内阻 Internal transistor resistance			110		$\mu\Omega$
$I_{SC}$	短路电流 Short circuit current, $I_{SC}$	$T_{vj} = 150\text{ }^{\circ}\text{C}, V_{CC} = 1000V,$ $V_{GE} \leq 15V, t_p \leq 10\mu\text{s},$ $V_{CE(max)} = V_{CES} - L^{(*2)} \times di/dt,$ IEC 6074-9		12000		A

注意: 1.(\*1) 表示该参数的测试点为辅助母排端子 (\*1) indicates it is measured at the auxiliary busbar terminal);

 2.(\*2) 表示L是电路杂散电感加上 $L_M$  (\*2) indicates L is the circuit stray inductance plus  $L_M$ ).

**TIM2400ESM17-TSA000**
**电特性值**
**Electrical Characteristics**

 除非特别声明，否则  $T_{\text{case}} = 25\text{ }^{\circ}\text{C}$ 
 $T_{\text{case}} = 25\text{ }^{\circ}\text{C}$  unless stated otherwise

符号 (Symbol)	参数名称 (Parameter)	测试条件 (Test Conditions)	最小 (Min)	典型 (Typ)	最大 (Max)	单位 (Unit)	
$t_{d(\text{off})}$	关断延迟时间 Turn-off delay time	$I_C = 2400\text{A}$ $V_{CE} = 900\text{V}$ $L_S \sim 50\text{nH}$ $V_{GE} = \pm 15\text{V}$ $R_{G(\text{ON})} = 0.5\Omega$ $R_{G(\text{OFF})} = 0.5\Omega$		2320		ns	
$t_f$	下降时间 Fall time			500		ns	
$E_{\text{OFF}}$	关断损耗 Turn-off energy loss				1050		mJ
$t_{d(\text{on})}$	开通延迟时间 Turn-on delay time				450		ns
$t_r$	上升时间 Rise time				210		ns
$E_{\text{ON}}$	开通损耗 Turn-on energy loss				410		mJ
$Q_{rr}$	二极管反向恢复电荷 Diode reverse recovery charge	$I_F = 2400\text{A}$ $V_{CE} = 900\text{V}$ $di_F/dt = 10000\text{A/us}$		480		$\mu\text{C}$	
$I_{rr}$	二极管反向恢复电流 Diode reverse recovery current				1000		A
$E_{rec}$	二极管反向恢复损耗 Diode reverse recovery energy				320		mJ

 除非特别声明，否则  $T_{\text{case}} = 125\text{ }^{\circ}\text{C}$ 
 $T_{\text{case}} = 125\text{ }^{\circ}\text{C}$  unless stated otherwise

符号 (Symbol)	参数名称 (Parameter)	测试条件 (Test Conditions)	最小 (Min)	典型 (Typ)	最大 (Max)	单位 (Unit)	
$t_{d(\text{off})}$	关断延迟时间 Turn-off delay time	$I_C = 2400\text{A}$ $V_{CE} = 900\text{V}$ $L_S \sim 50\text{nH}$ $V_{GE} = \pm 15\text{V}$ $R_{G(\text{ON})} = 0.5\Omega$ $R_{G(\text{OFF})} = 0.5\Omega$		2340		ns	
$t_f$	下降时间 Fall time			510		ns	
$E_{\text{OFF}}$	关断损耗 Turn-off energy loss				1320		mJ
$t_{d(\text{on})}$	开通延迟时间 Turn-on delay time				450		ns
$t_r$	上升时间 Rise time				220		ns
$E_{\text{ON}}$	开通损耗 Turn-on energy loss				660		mJ
$Q_{rr}$	二极管反向恢复电荷 Diode reverse recovery charge	$I_F = 2400\text{A}$ $V_{CE} = 900\text{V}$ $di_F/dt = 10000\text{A/us}$		750		$\mu\text{C}$	
$I_{rr}$	二极管反向恢复电流 Diode reverse recovery current				1200		A
$E_{rec}$	二极管反向恢复损耗 Diode reverse recovery energy				550		mJ

**电特性值**
**Electrical Characteristics**

 除非特别声明，否则  $T_{\text{case}} = 150\text{ }^{\circ}\text{C}$ 
 $T_{\text{case}} = 150\text{ }^{\circ}\text{C}$  unless stated otherwise

符号 (Symbol)	参数名称 (Parameter)	测试条件 (Test Conditions)	最小 (Min)	典型 (Typ)	最大 (Max)	单位 (Unit)
$t_{\text{d(off)}}$	关断延迟时间 Turn-off delay time	$I_{\text{C}} = 2400\text{A}$ $V_{\text{CE}} = 900\text{V}$ $L_{\text{S}} \sim 50\text{nH}$ $V_{\text{GE}} = \pm 15\text{V}$ $R_{\text{G(ON)}} = 0.5\Omega$ $R_{\text{G(OFF)}} = 0.5\Omega$		2340		ns
$t_{\text{f}}$	下降时间 Fall time			510		ns
$E_{\text{OFF}}$	关断损耗 Turn-off energy loss			1400		mJ
$t_{\text{d(on)}}$	开通延迟时间 Turn-on delay time			450		ns
$t_{\text{r}}$	上升时间 Rise time			220		ns
$E_{\text{ON}}$	开通损耗 Turn-on energy loss			820		mJ
$Q_{\text{rr}}$	二极管反向恢复电荷 Diode reverse recovery charge		$I_{\text{F}} = 2400\text{A}$ $V_{\text{CE}} = 900\text{V}$ $di_{\text{F}}/dt = 12000\text{A}/\mu\text{s}$		820	
$I_{\text{rr}}$	二极管反向恢复电流 Diode reverse recovery current			1250		A
$E_{\text{rec}}$	二极管反向恢复损耗 Diode reverse recovery energy			620		mJ

TIM2400ESM17-TSA000



图3. 输出特性典型曲线

Fig.3 Typical output characteristics

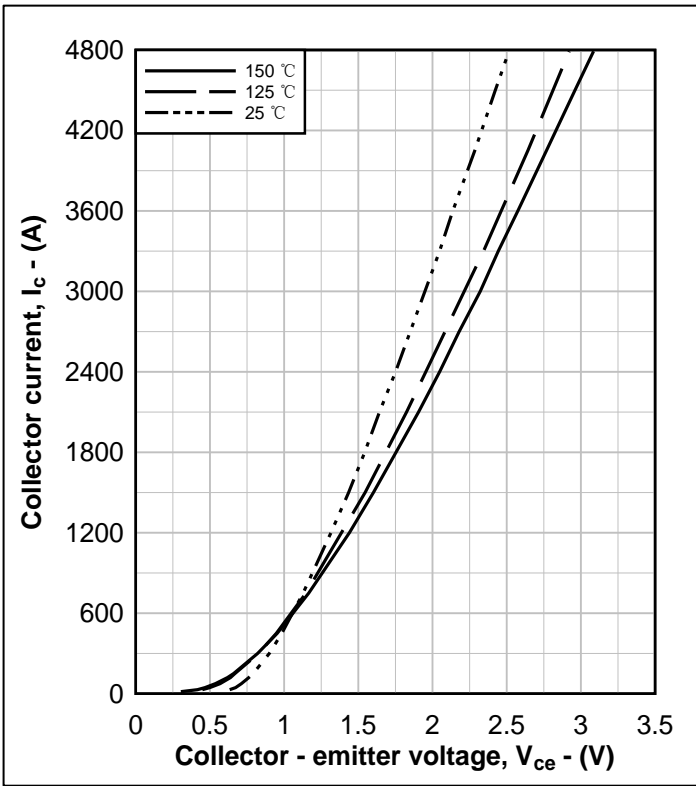

图4. 输出特性典型曲线

Fig.4 Typical output characteristics

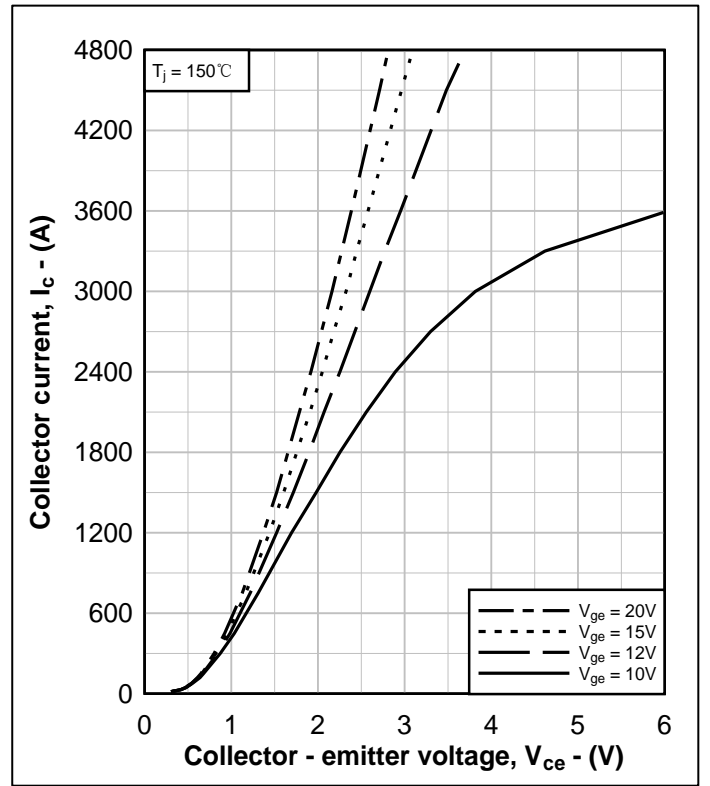

图5. 开关能耗与集电极电流关系曲线

Fig.5 Typical switching energy vs collector current

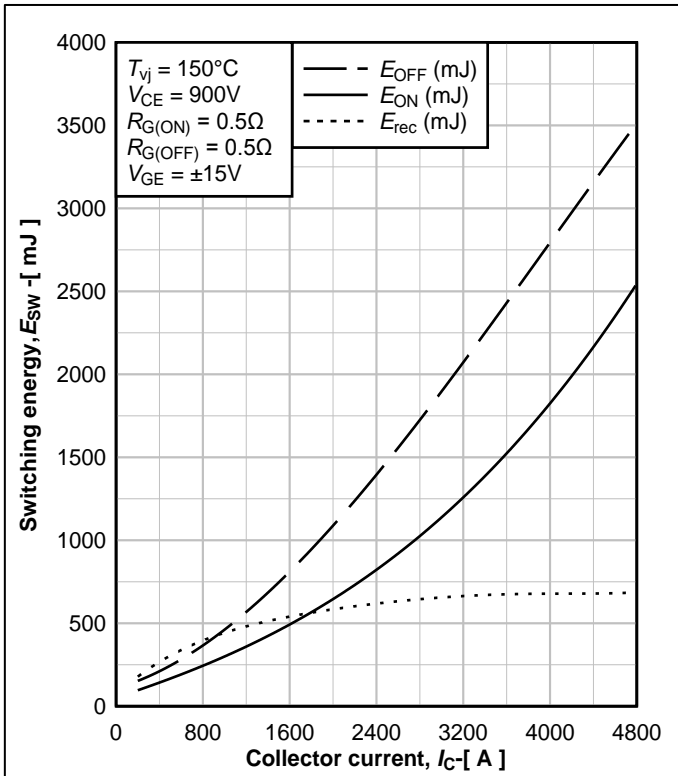

图6. 开关能耗与栅极电阻的关系曲线

Fig. 6 Typical switching energy vs gate resistance

TIM2400ESM17-TSA000

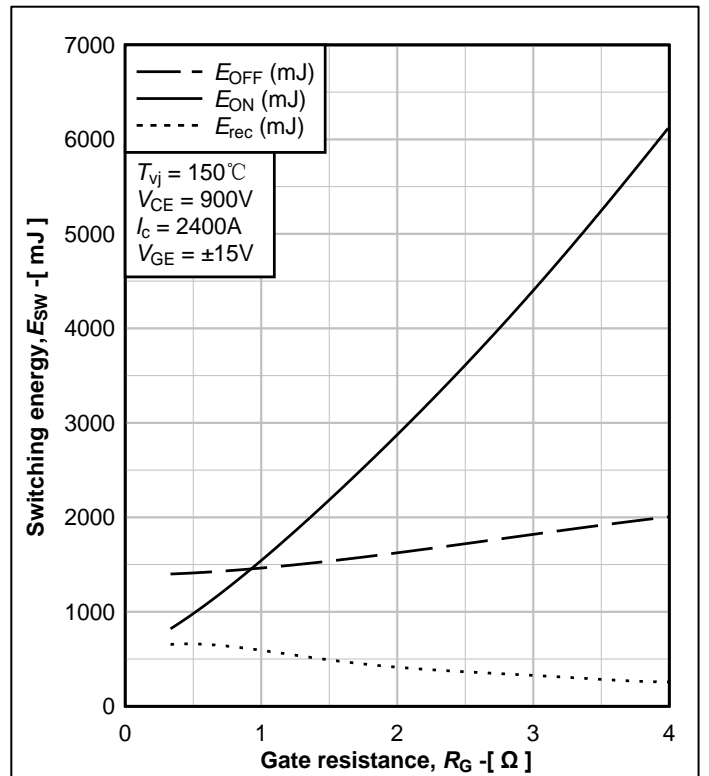

图7. 二极管正向特性典型曲线

Fig.7 Diode typical forward characteristics

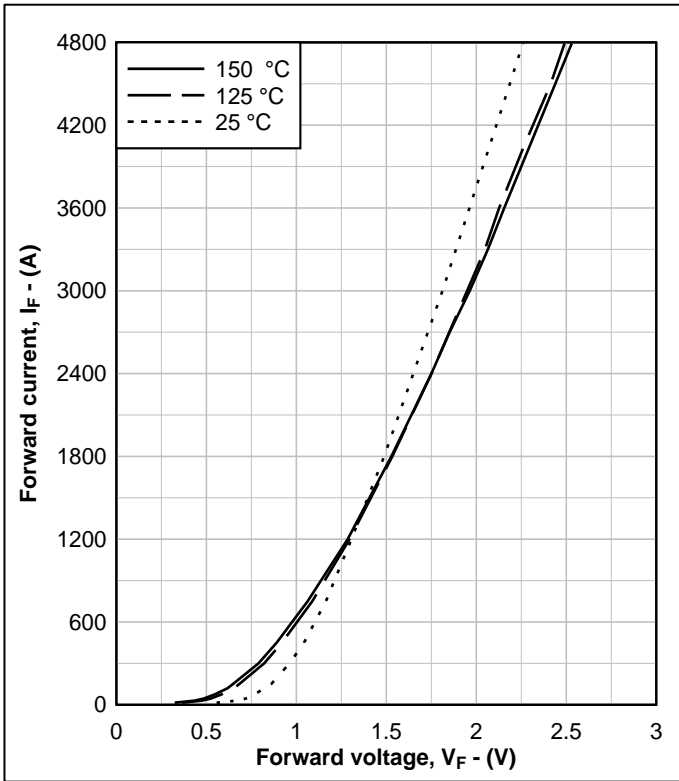

图8. 反偏安全工作区

Fig.8 Reverse bias safe operating area

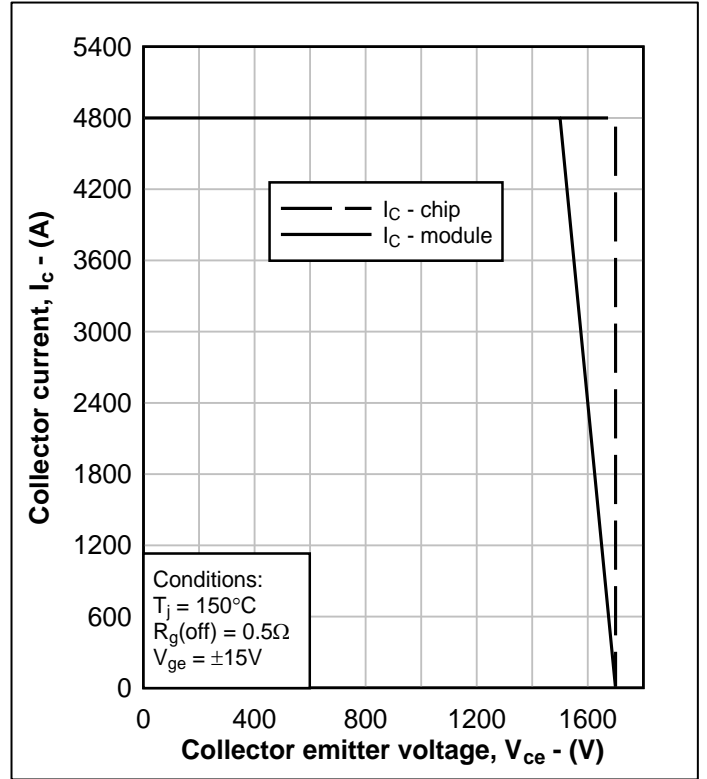

图9. 瞬态热阻抗曲线

Fig. 9 Transient thermal impedance

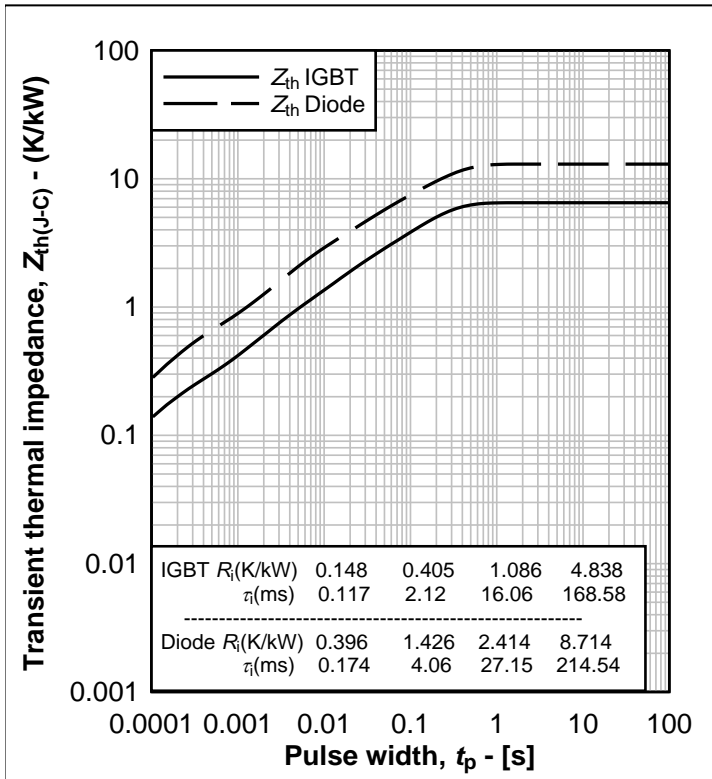
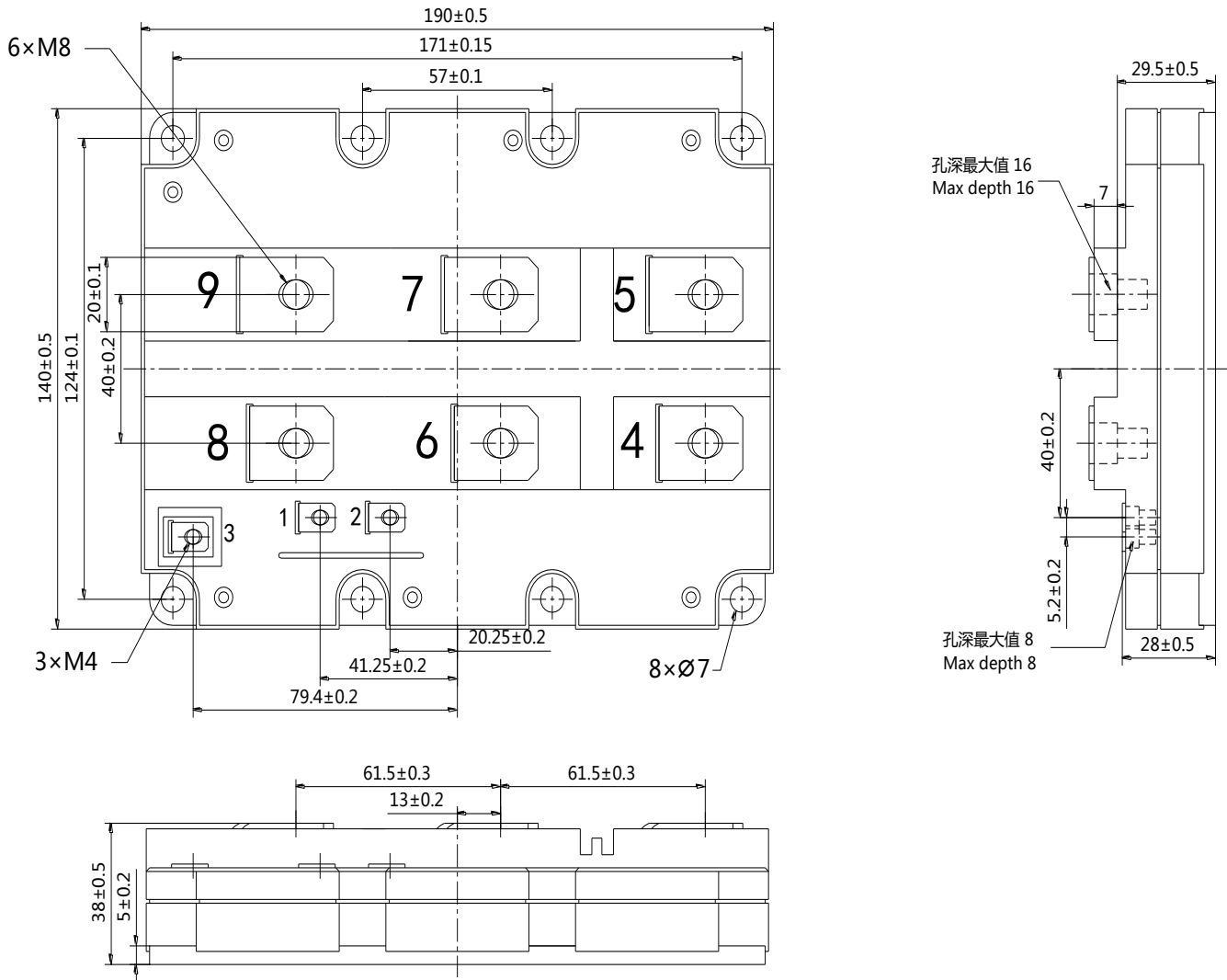

重量Weight: 1400g

模块外观类型 Module outline code: E

图10. 模块外观尺寸

Fig. 10 Module outline drawing

株洲中车时代半导体有限公司

ZHUZHOU CRRC TIMES SEMICONDUCTOR CO., LTD

地 址	Address	湖南省株洲市石峰区田心工业园	Tianxin Industrial Park, Shifeng District, ZhuZhou City, Hunan Province, China
邮 编	Zipcode	412001	
电 话	Telephone	0731-28498268, 28498238, 28493472	
传 真	Fax	0731-28498851, 28498494	
电子邮箱	Email	pebu@csrzc.com	
网 址	Web Site	http://www.pebu.csrzc.com	



## 使用条件和条款

(1) 数据手册中的产品信息是专门为技术人员提供的。由于产品应用的多样性，本文件所包含的信息只能作为一般性指南，无法保证其在某些特殊应用中的适用性，建议用户在使用前评估产品的适用性。如果需要额外的产品信息和帮助，请联系我公司的销售或技术支持。

(2) 本产品数据手册中提供的一部分产品数据是产品的典型值，实际出厂测试的产品数据可能与典型值略有偏离，但我公司保证这些偏离不会影响产品的正常使用。如果产品信息发生变更，我公司会及时修订产品数据手册，请随时关注我公司网站发布的产品手册信息。

(3) 如果对本产品有特殊要求，或用于特殊行业（如航空航天、医疗、生命维持等），强烈建议用户与我公司联合进行应用风险和产品质量评估，建立统一的质量协议。

(4) 产品使用过程中，如有超出产品数据手册中所定义的产品极限温度、电压、电流或安全工作区范围的情况，我公司无法保证产品的应用可靠性。

(5) 产品在使用时，严禁触碰。产品断电后，在确保无电荷残留、产品已冷却后，才可以在有静电防护措施的情况下触碰产品。

(6) 产品数据手册首页的右上角，会显示产品的状态。如果它尚未完全批准，会标示**初版 (preliminary)**，该标示意味着该产品已完成设计，量产的产品参数正在确定中，数据手册中的产品信息目前是可以参考的，但将来某些细节可能会发生变化。如果产品数据手册首页的右上角没有标注，则表示该产品已可以批量生产。

## Terms and conditions of usage

(1) The product information in this datasheet are intended for use by technical personnel. Due to the diversity of product applications, the information contained in this document can only be used as a general guide, the application applicability cannot be guaranteed in some special applications. It is recommended that users do the assessment of the application applicability before applied. If users need additional product information and help, please contact our sales or technical support.

(2) Some product data in the datasheet of this product are the typical values, the actual factory testing data may deviate slightly from typical values, but our company guarantees that these deviations will not affect the normal use of the product. If the product information changes, our company will promptly amend the datasheet, please keeps your attention to product information changing in our company website.

(3) If there are special requirements for the product, or apply it in special industries (such as aerospace, medical, life support, etc.), we strongly recommend that to perform joint application risk and quality assessments, get the quality agreements.

(4) During the application, if the working conditions are beyond the limitation of temperature, voltage, current or safe operating area of the product defined in the product datasheet, our company cannot guarantee the reliability of the product.

(5) When the products are in use, it is strictly prohibited to touch. After power off, to ensure that there is no residual charge and the products have been cooled before they can be touched. And all operations must be under ESD protection measures.

(6) We annotate datasheet in the top right hand corner of the front page, to indicate product status. The annotation "Preliminary" indicates the product design is complete and final characterization for volume production is in progress, the product information in the datasheet is currently can be referenced, but some details may change in the future. There is no annotation indicates the product is capable to produce in batch quantity.