

关键参数 Key Parameters

V_{CES}		1200	V
$V_{CE(sat)}$	Typ.	1.65	V
I_C	Max.	450	A
$I_{C(RM)}$	Max.	900	A

典型应用 Typical Applications

● 电动汽车	Electrical Vehicles
● 充电装置	Power Charging Equipment
● 光伏发电	Solar Power
● 高可靠性逆变器	High Reliability Inverter

特点 Features

● 铜基板	Cu Baseplate
● 增强型氧化铝衬板	Enhanced Al_2O_3 Substrates
● 高热循环能力	High Thermal Cycling Capability
● 10 μ s 短路承受能力	10 μ s Short Circuit Withstand

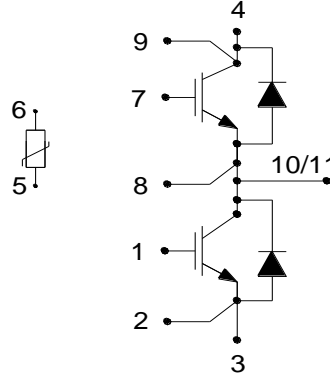
电路结构 Circuit Configuration

1. 电路结构

Fig. 1 Circuit configuration

模块外形 Module Appearance

图 2. 模块外形

Fig. 2 Module appearance

模块标签说明
Module Label Code Instruction

数据位置 Data position	数据内容 Content of data
1--8	模块批次号 Module batch number
9--16	模块序列号 Module serial number

最大额定值
Absolute Maximum Ratings

符号 Symbol	参数名称 Parameter	测试条件 Test Conditions	数值 Value	单位 Unit
V_{CES}	集电极-发射极电压 Collector-emitter voltage	$V_{GE} = 0V, T_C = 25\text{ }^\circ\text{C}$	1200	V
V_{GES}	栅极-发射极电压 Gate-emitter voltage	$T_C = 25\text{ }^\circ\text{C}$	± 20	V
I_C	集电极电流 Collector-emitter current	$T_C = 100\text{ }^\circ\text{C}, T_{vjmax} = 175\text{ }^\circ\text{C}$	450	A
$I_{C(PK)}$	集电极峰值电流 Peak collector current	$t_p = 1\text{ms}$	900	A
P_{max}	晶体管部分最大损耗 Max. transistor power dissipation	$T_{vj} = 175\text{ }^\circ\text{C}, T_C = 25\text{ }^\circ\text{C}$	2.80	kW
\hat{r}_t	二极管 \hat{r}_t 值 Diode \hat{r}_t	$V_R = 0V, t_p = 10\text{ms}, T_{vj} = 150\text{ }^\circ\text{C}$	27.2	kA^2s
V_{isol}	绝缘电压(模块) Isolation voltage – per module	短接所有端子，端子与基板间施加电压 (Commoned terminals to base plate), AC RMS, 1 min, 50Hz, $T_C = 25\text{ }^\circ\text{C}$	2500	V

热和机械数据
Thermal & Mechanical Data

参数 Symbol	说明 Explanation	值 Value	单位 Unit
爬电距离 Creepage distance	端子-散热器 Terminal to heatsink	14.5	mm
	端子-端子 Terminal to terminal	13.0	mm
绝缘间隙 Clearance	端子-散热器 Terminal to heatsink	12.5	mm
	端子-端子 Terminal to terminal	10.0	mm
相对漏电起痕指数 CTI (Comparative Tracking Index)		>200	

热和机械数据
Thermal & Mechanical Data

符号 Symbol	参数名称 Parameter	测试条件 Test Conditions	最小值 Min.	典型值 Typ.	最大值 Max.	单位 Unit
$R_{th(J-C)}$ IGBT	IGBT 结壳热阻 Thermal resistance – IGBT				52	K / kW
$R_{th(J-C)}$ Diode	二极管结壳热阻 Thermal resistance – Diode				86	K / kW
$R_{th(C-H)}$ IGBT	接触热阻(IGBT) Thermal resistance – case to heatsink (IGBT)	安装力矩 5Nm, 导热脂 1W/m·°C Mounting torque 5Nm, with mounting grease 1W/m·°C		30		K / kW
$R_{th(C-H)}$ Diode	接触热阻(Diode) Thermal resistance – case to heatsink (Diode)	安装力矩 5Nm, 导热脂 1W/m·°C Mounting torque 5Nm, with mounting grease 1W/m·°C		45		K / kW
$T_{vj\ op}$	工作结温 Operating junction temperature	IGBT 部分 (IGBT)	-40		150	°C
		二极管部分(Diode)	-40		150	°C
T_{stg}	存储温度 Storage temperature range		-40		125	°C
M	安装力矩 Screw torque	安装紧固用 - M5 Mounting - M5	3		6	Nm
		电路互连用- M6 Electrical connections - M6	3		6	Nm

热敏电阻数据
NTC-Thermistor Data

符号 Symbol	参数名称 Parameter	测试条件 Test Conditions	最小值 Min.	典型值 Typ.	最大值 Max.	单位 Unit
R_{25}	额定电阻值 Rated resistance	$T_C = 25\ ^\circ\text{C}$		5		kΩ
$\Delta R/R$	R 100 偏差 Deviation of R100	$T_C = 100\ ^\circ\text{C}, R_{100}=493\Omega$	-5		5	%
P_{25}	耗散功率 Power dissipation	$T_C = 25\ ^\circ\text{C}$			20	mW
$B_{25/50}$	B -值 B -value	$R_2 = R_{25}\exp [B_{25/50}(1/T_2 - 1/(298.15\text{ K}))]$		3375		K
$B_{25/80}$	B -值 B -value	$R_2 = R_{25}\exp [B_{25/80}(1/T_2 - 1/(298.15\text{ K}))]$		3411		K
$B_{25/100}$	B -值 B -value	$R_2 = R_{25}\exp [B_{25/100}(1/T_2 - 1/(298.15\text{ K}))]$		3433		K

电特性值
Electrical Characteristics

 除非特别声明，否则 $T_C = 25\text{ }^\circ\text{C}$
 $T_C = 25\text{ }^\circ\text{C}$ unless otherwise stated

符号 Symbol	参数名称 Parameter	条件 Test Conditions	最小值 Min.	典型值 Typ.	最大值 Max.	单位 Unit
I_{CES}	集电极截止电流 Collector cut-off current	$V_{GE} = 0V, V_{CE} = V_{CES}$			1	mA
		$V_{GE} = 0V, V_{CE} = V_{CES}, T_C = 125\text{ }^\circ\text{C}$			10	mA
		$V_{GE} = 0V, V_{CE} = V_{CES}, T_C = 150\text{ }^\circ\text{C}$			20	mA
I_{GES}	栅极漏电流 Gate leakage current	$V_{GE} = \pm 20V, V_{CE} = 0V$			0.5	μA
$V_{GE(TH)}$	栅极-发射极阈值电压 Gate threshold voltage	$I_C = 15\text{mA}, V_{GE} = V_{CE}$	5.30	5.90	6.50	V
$V_{CE(sat)}^{(*1)}$	集电极-发射极饱和电压 Collector-emitter saturation voltage	$V_{GE} = 15V, I_C = 450A$		1.65	2.05	V
		$V_{GE} = 15V, I_C = 450A, T_{vj} = 125\text{ }^\circ\text{C}$		1.95	2.35	V
		$V_{GE} = 15V, I_C = 450A, T_{vj} = 150\text{ }^\circ\text{C}$		2.00	2.40	V
I_F	二极管正向直流电流 Diode forward current	DC		450		A
I_{FRM}	二极管正向重复峰值电流 Diode peak forward current	$t_p = 1\text{ms}$		900		A
$V_F^{(*1)}$	二极管正向电压 Diode forward voltage	$I_F = 450A, V_{GE} = 0$		1.65	2.05	V
		$I_F = 450A, V_{GE} = 0, T_{vj} = 125\text{ }^\circ\text{C}$		1.75	2.15	V
		$I_F = 450A, V_{GE} = 0, T_{vj} = 150\text{ }^\circ\text{C}$		1.75	2.15	V
I_{SC}	短路电流 Short circuit current	$T_{vj} = 150\text{ }^\circ\text{C}, V_{CC} = 800V,$ $V_{GE} \leq 15V, t_p \leq 10\mu\text{s},$ $V_{CE(max)} = V_{CES} - L^{(*2)} \times di/dt,$ IEC 6074-9		1900		A

注意: 1.(*1) 表示该参数的测试点为辅助母排端子 (*1) indicates it is measured at the auxiliary busbar terminal),

Note: 2.(*2) 表示 L 是电路杂散电感加上 L_M (*2) indicates L is the circuit stray inductance plus L_M).

电特性值
Electrical Characteristics

 除非特别声明, 否则 $T_C = 25\text{ }^\circ\text{C}$
 $T_C = 25\text{ }^\circ\text{C}$ unless otherwise stated

符号 Symbol	参数名称 Parameter	条件 Test Conditions	最小值 Min.	典型值 Typ.	最大值 Max.	单位 Unit
C_{ies}	输入电容 Input capacitance	$V_{CE} = 25V, V_{GE} = 0V, f = 100kHz$		62		nF
Q_g	栅极电荷 Gate charge	$\pm 15V$		4.6		μC
C_{res}	反向传输电容 Reverse transfer capacitance	$V_{CE} = 25V, V_{GE} = 0V, f = 100kHz$		0.82		nF
L_M	模块电感 Module inductance			20		nH
R_{INT}	内阻 Internal transistor resistance			1.1		m Ω

电特性值
Electrical Characteristics

符号 Symbol	参数名称 Parameter	测试条件 Test Conditions	最小值 Min.	典型值 Typ.	最大值 Max.	单位 Unit	
$t_{d(off)}$	关断延迟时间 Turn-off delay time	$I_C = 450A,$ $V_{CE} = 600V,$ $V_{GE} = \pm 15V,$ $R_{G(OFF)} = 2.2\Omega,$ $L_S = 50nH,$ $dv/dt = 4500V/us$ ($T_{vj} = 150^\circ C$).	$T_{vj} = 25^\circ C$	680		ns	
			$T_{vj} = 125^\circ C$	720			
			$T_{vj} = 150^\circ C$	730			
t_f	下降时间 Fall time		$T_{vj} = 25^\circ C$		130		ns
			$T_{vj} = 125^\circ C$		240		
			$T_{vj} = 150^\circ C$		270		
E_{OFF}	关断损耗 Turn-off energy loss		$T_{vj} = 25^\circ C$		46		mJ
			$T_{vj} = 125^\circ C$		59		
			$T_{vj} = 150^\circ C$		62		
$t_{d(on)}$	开通延迟时间 Turn-on delay time	$T_{vj} = 25^\circ C$		262		ns	
		$T_{vj} = 125^\circ C$		265			
		$T_{vj} = 150^\circ C$		267			
t_r	上升时间 Rise time	$T_{vj} = 25^\circ C$		95		ns	
		$T_{vj} = 125^\circ C$		100			
		$T_{vj} = 150^\circ C$		102			
E_{ON}	开通损耗 Turn-on energy loss	$T_{vj} = 25^\circ C$		19		mJ	
		$T_{vj} = 125^\circ C$		24			
		$T_{vj} = 150^\circ C$		30			
Q_{rr}	二极管反向恢复电荷 Diode reverse recovery charge	$T_{vj} = 25^\circ C$		52		μC	
		$T_{vj} = 125^\circ C$		88			
		$T_{vj} = 150^\circ C$		100			
I_{rr}	二极管反向恢复电流 Diode reverse recovery current	$T_{vj} = 25^\circ C$		350		A	
		$T_{vj} = 125^\circ C$		420			
		$T_{vj} = 150^\circ C$		440			
E_{rec}	二极管反向恢复损耗 Diode reverse recovery energy	$T_{vj} = 25^\circ C$		25		mJ	
		$T_{vj} = 125^\circ C$		45			
		$T_{vj} = 150^\circ C$		50			



图 3. IGBT 输出特性典型曲线, $I_C = f(V_{CE})$

Fig.3 Typical IGBT output characteristics, $I_C = f(V_{CE})$

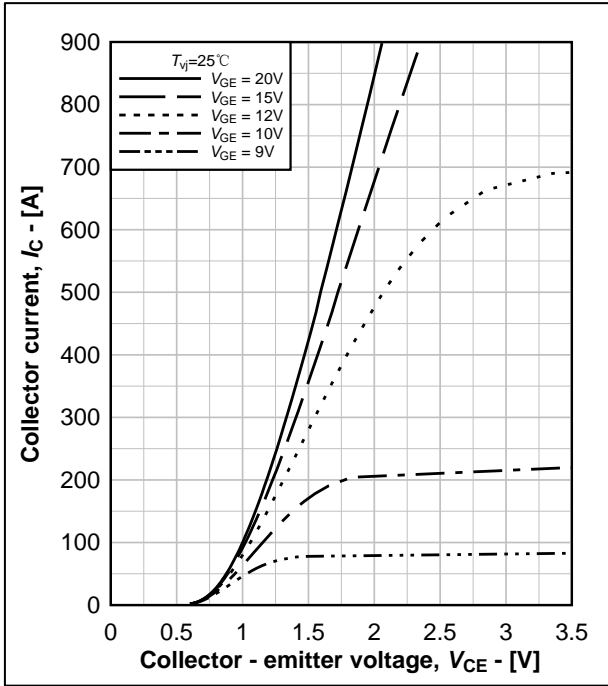

图 4. IGBT 输出特性典型曲线, $I_C = f(V_{CE})$

Fig.4 Typical IGBT output characteristics, $I_C = f(V_{CE})$

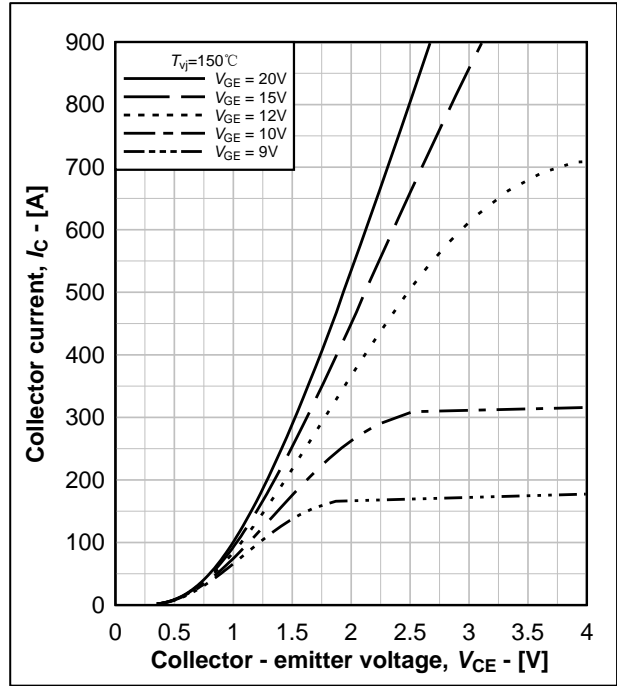

图 5. IGBT 输出特性典型曲线, $I_C = f(V_{CE})$

Fig.5 Typical IGBT output characteristics, $I_C = f(V_{CE})$

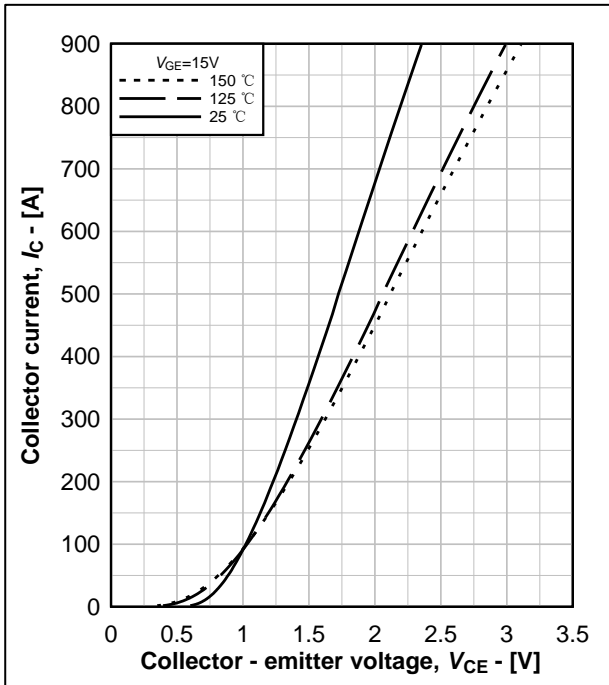

图 6. IGBT 传输特性典型曲线, $I_C = f(V_{GE})$

Fig.6 Typical IGBT transfer characteristics, $I_C = f(V_{GE})$

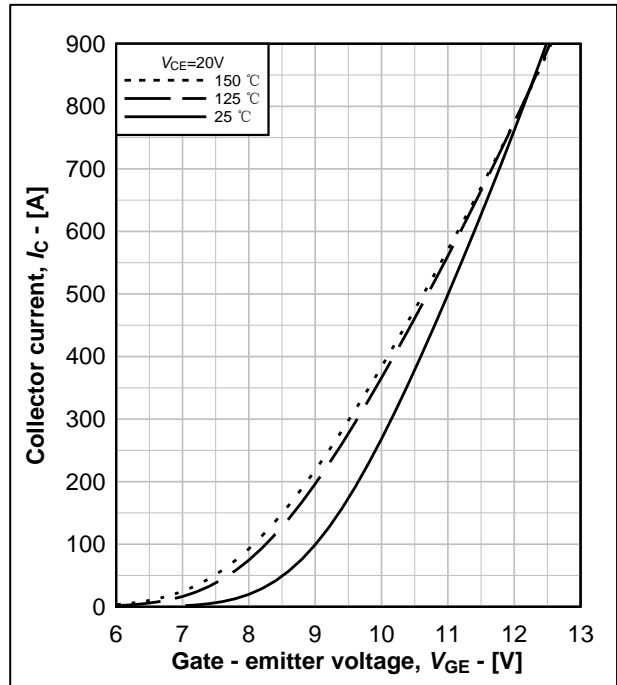

图 7. FRD 输出特性典型曲, $I_F = f(V_F)$

Fig.7 Typical FRD output characteristics, $I_F = f(V_F)$

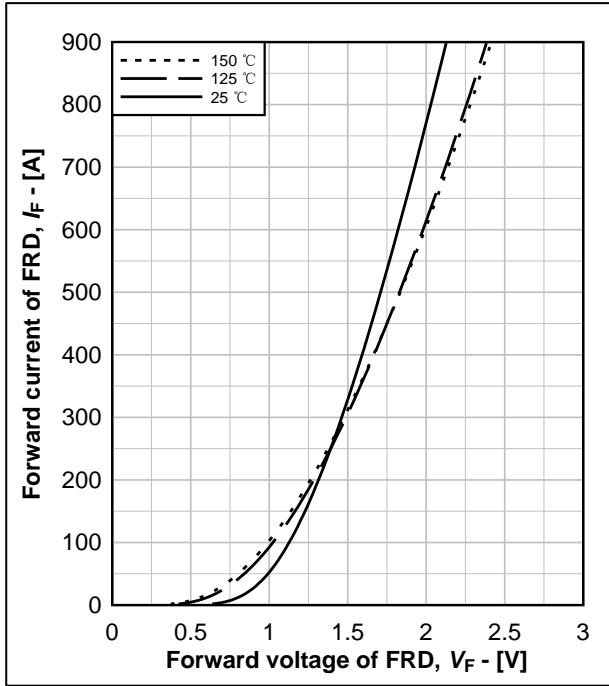

图 8. FRD 反向恢复能耗典型曲线, $E_{rec}=f(R_G)$

Fig.8 Typical FRD E_{rec} , $E_{rec}=f(R_G)$

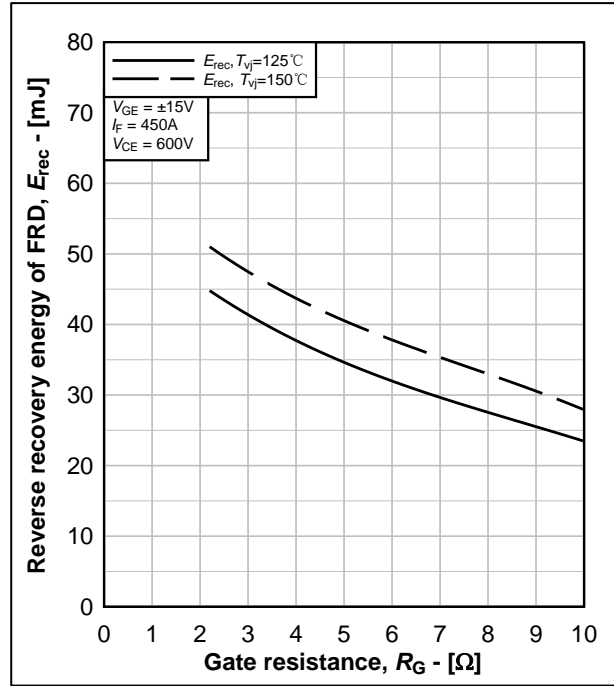

图 9. FRD 反向恢复能耗典型曲线, $E_{rec}=f(I_F)$

Fig.9 Typical FRD E_{rec} , $E_{rec}=f(I_F)$

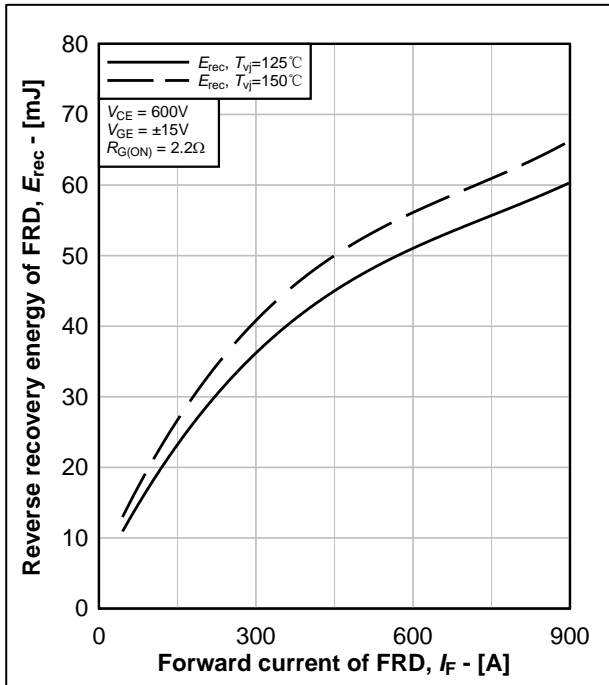

图 10. IGBT 开关能耗典型曲线, $E_{on}=f(I_c)$, $E_{off}=f(I_c)$

Fig.10 Typical IGBT switching energy, $E_{on}=f(I_c)$, $E_{off}=f(I_c)$

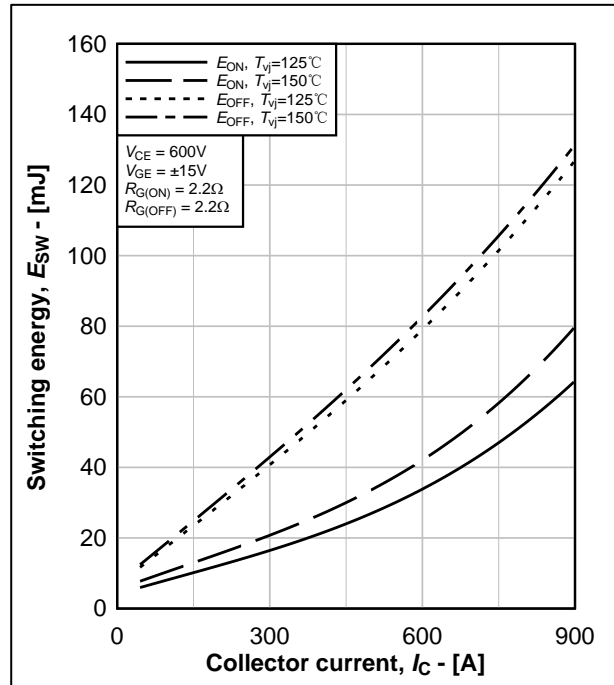

 图 11. IGBT 开关能耗典型曲线, $E_{on} = f(R_G)$, $E_{off} = f(R_G)$

 Fig.11 Typical IGBT switching energy,
 $E_{on} = f(R_G)$, $E_{off} = f(R_G)$

 图 12. 热敏电阻典型特性曲线, $R = f(T_C)$

 Fig.12 Typical NTC thermistor characteristic, $R = f(T_C)$

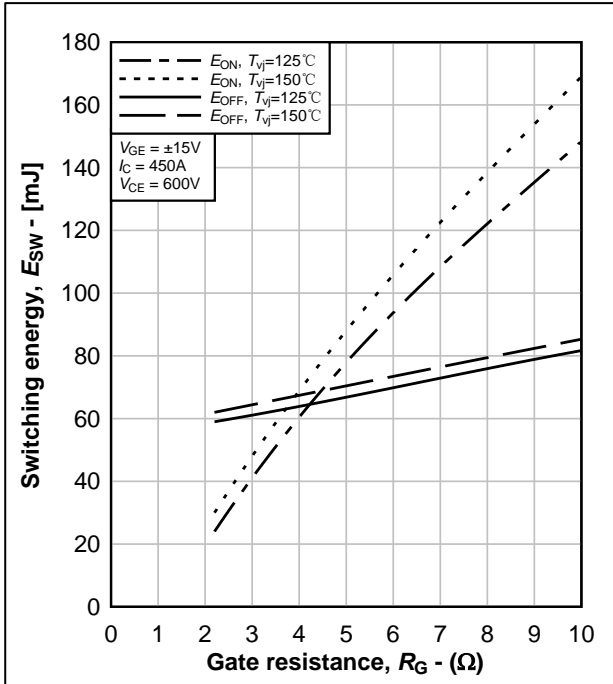
 图 13. IGBT 反偏安全工作区, $I_C = f(V_{CE})$

 Fig.13 Reverse bias safe operating area of IGBT,
 $I_C = f(V_{CE})$

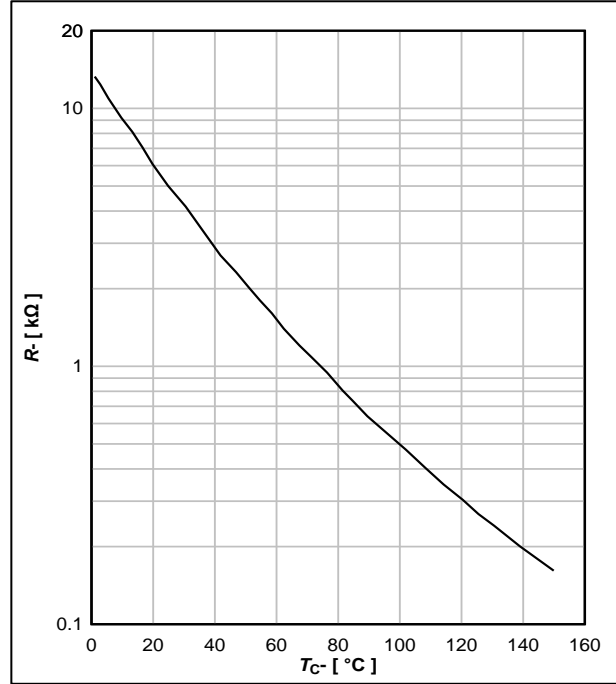
 图 14. 瞬态热阻抗曲线, $Z_{Th(J-C)} = f(t_p)$

 Fig.14 Transient thermal impedance, $Z_{Th(J-C)} = f(t_p)$

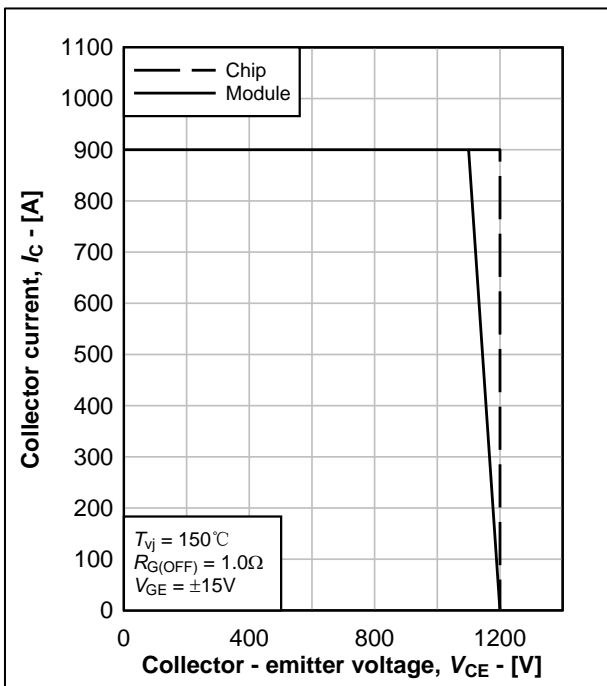

重量 Weight: 345g

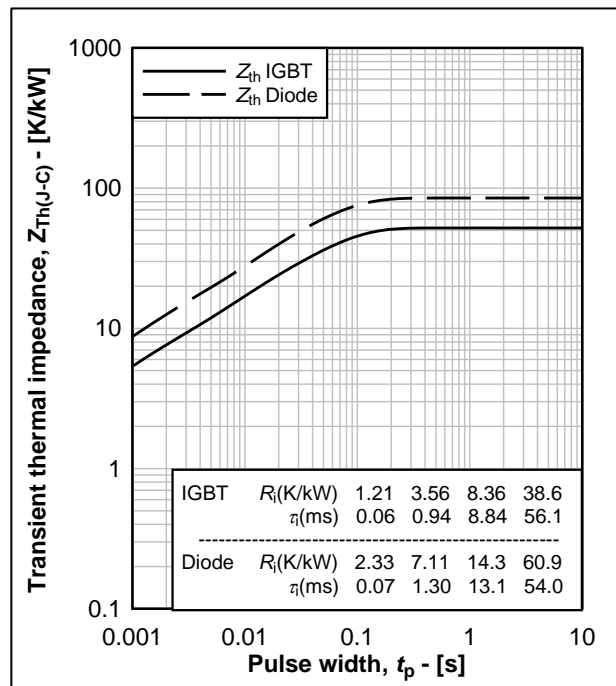
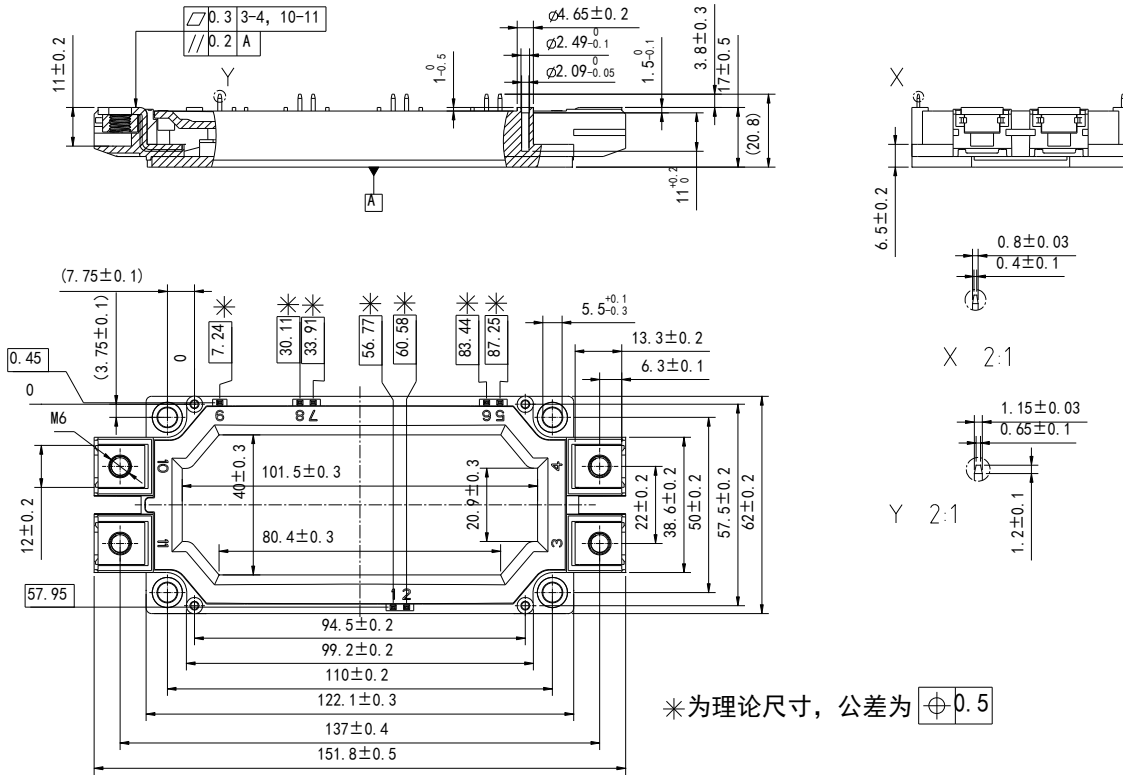
模块外观类型 Module outline code: M1

图 15. 模块外观尺寸

Fig. 15 Module outlines

株洲中车时代半导体有限公司

ZHUZHOU CRRC TIMES SEMICONDUCTOR CO., LTD

地址	Address	湖南省株洲市石峰区田心工业园	Tianxin Industrial Park, Shifeng District, ZhuZhou City, Hunan Province, China
邮编	Zipcode	412001	
电话	Telephone	+86 (0)731-28498268, 28498238, 28493472	
传真	Fax	+86 (0)731-28498851, 28498494	
电子邮箱	Email	sbu@crcczic.cc	
网址	Web Site	http://www.sbu.crcczic.cc	

使用条件和条款

(1) 数据手册中的产品信息是专门为技术人员提供的。由于产品应用的多样性，本文件所包含的信息只能作为一般性指南，无法保证其在某些特殊应用中的适用性，建议用户在使用前评估产品的适用性。如果需要额外的产品信息和帮助，请联系我公司的销售或技术支持。

(2) 本产品数据手册中提供的一部分产品数据是产品的典型值，实际出厂测试的产品数据可能与典型值略有偏离，但我公司保证这些偏离不会影响产品的正常使用。如果产品信息发生变更，我公司会及时修订产品数据手册，请随时关注我公司网站发布的产品手册信息。

(3) 如果对本产品有特殊要求，或用于特殊行业（如航空航天、医疗、生命维持等），强烈建议用户与我公司联合进行应用风险和产品质量评估，建立统一的质量协议。

(4) 产品使用过程中，如有超出产品数据手册中所定义的产品极限温度、电压、电流或安全工作区范围的情况，我公司无法保证产品的应用可靠性。

(5) 产品在使用时，严禁触碰。产品断电后，在确保无电荷残留、产品已冷却后，才可以在有静电防护措施的情况下触碰产品。

(6) 产品数据手册首页的右上角，会显示产品的状态。如果它尚未完全批准，会标示**初版 (preliminary)**，该标示意味着该产品已完成设计，量化的产品参数正在确定中，数据手册中的产品信息目前是可以参考的，但将来某些细节可能会发生变化。如果产品数据手册首页的右上角没有标注，则表示该产品已可以批量生产。

Terms and conditions of usage

(1) The product information in this datasheet are intended for use by technical personnel. Due to the diversity of product applications, the information contained in this document can only be used as a general guide, the application applicability cannot be guaranteed in some special applications. It is recommended that users do the assessment of the application applicability before applied. If users need additional product information and help, please contact our sales or technical support.

(2) Some product data in the datasheet of this product are the typical values, the actual factory testing data may deviate slightly from typical values, but our company guarantees that these deviations will not affect the normal use of the product. If the product information changes, our company will promptly amend the datasheet, please keeps your attention to product information changing in our company website.

(3) If there are special requirements for the product, or apply it in special industries (such as aerospace, medical, life support, etc.), we strongly recommend that to perform joint application risk and quality assessments, get the quality agreements.

(4) During the application, if the working conditions are beyond the limitation of temperature, voltage, current or safe operating area of the product defined in the product datasheet, our company cannot guarantee the reliability of the product.

(5) When the products are in use, it is strictly prohibited to touch. After power off, to ensure that there is no residual charge and the products have been cooled before they can be touched. And all operations must be under ESD protection measures.

(6) We annotate datasheet in the top right hand corner of the front page, to indicate product status. The annotation "Preliminary" indicates the product design is complete and final characterization for volume production is in progress, the product information in the datasheet is currently can be referenced, but some details may change in the future. There is no annotation indicates the product is capable to produce in batch quantity.